

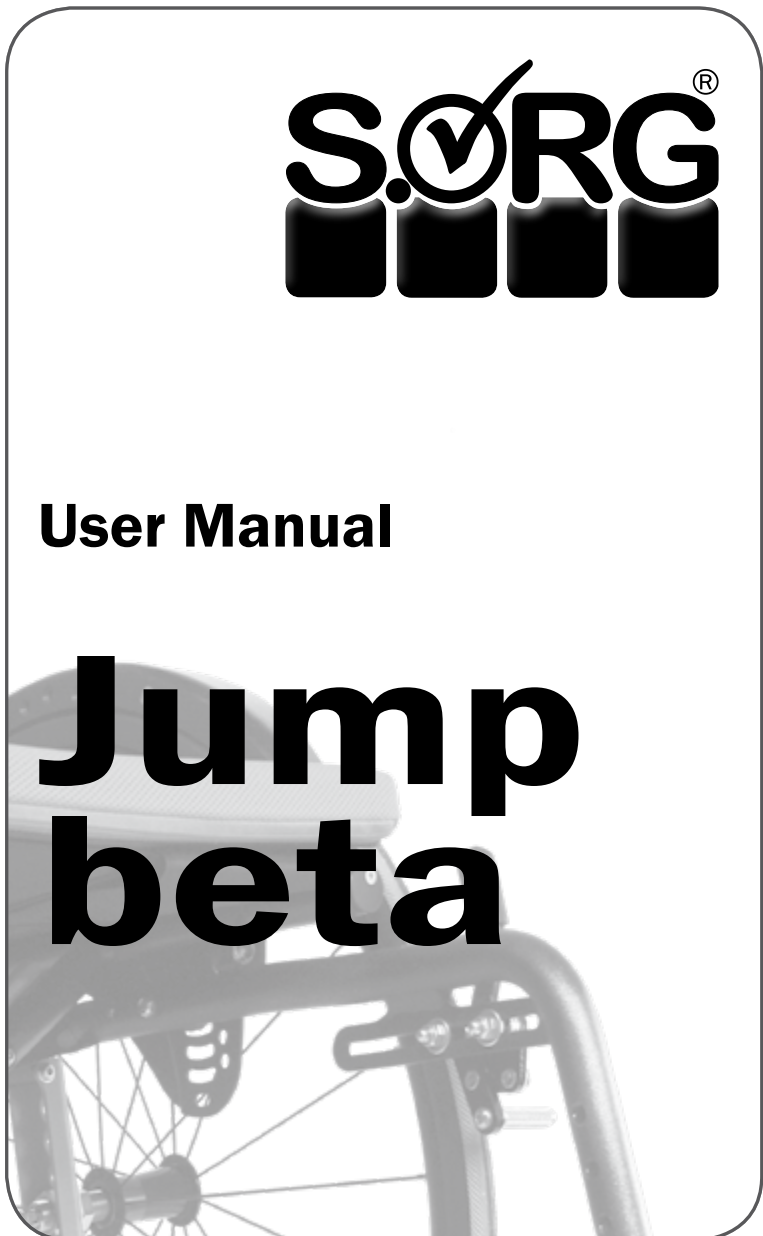

**User Manual**

# Jump beta



## IIIMPRINT

SORG Rollstuhltechnik GmbH+Co.KG  
Benzstraße 3-5  
D-68794 Oberhausen-Rheinhausen  
Germany

Tel. +49 7254-9279-0  
Fax +49 7254-9279-10  
E-mail info@sorgrollstuhltechnik.de  
Web www.sorgrollstuhltechnik.de

## REVISION STATUS

Revision: 03.08.2018, 08:02

## TECHNICAL STATUS

Technical changes and misprints reserved. The pictures in this user manual can – depending on the individual equipment – differ from the actual equipment components. However, a corresponding conduction is possible.



## rehaKIND



We are a member of rehaKIND e.V.  
International association  
child and adolescent rehabilitation

## COPYRIGHT

© by SORG Rollstuhltechnik GmbH + Co. KG Benzstraße 3-5, 68794 Oberhausen-Rheinhausen.  
All texts and pictures in this user manual underlie the international copyright protection and are not allowed to be published without our consent – not even in excerpts!

## CERTIFICATION

We are certified according to the Quality Management System ISO 90001:2008 under the certificate no. 12 100 20070 at TÜV SÜD.



<b>IIMPRINT</b>	2	<b>3.10. Side guards</b>	29
<b>REVISION STATUS</b>	2	<b>3.10.1 Standard side guards</b>	29
<b>TECHNICAL STATUS</b>	2	<b>3.10.2 Desk side guards/side guards long</b>	29
<b>rehaKIND</b>	2	<b>3.11 Armrests</b>	29
<b>COPYRIGHT</b>	2	<b>3.12 Leg supports</b>	30
<b>CERTIFICATION</b>	2	<b>3.12.1 Footrests can be folded to the side or to the back</b>	30
<b>WHEELCHAIR OVERVIEW</b>	4	<b>3.12.2 Leg support with continuous footrest: can be elevated and swings to the side</b>	30
		<b>3.12.3 Leg support detachable and swings to the side</b>	31
<b>1 Preamble</b>	5	<b>3.12.4 Leg support can be elevated</b>	31
<b>1.1 General Information</b>	5	<b>3.12.5 Locking mechanism for continuous footrest</b>	32
<b>1.2 Signs and Symbols</b>	5	<b>3.13. Brakes</b>	32
<b>1.3 Indication Jump beta</b>	5	<b>3.13.1 Braking while driving</b>	32
<b>1.4 Counter indication Jump beta</b>	5	<b>3.13.2 Knee lever brake (wheel lock)</b>	33
<b>1.6 Application</b>	6	<b>3.13.3 Drum brake as driving brake</b>	33
<b>1.5 Specification Jump beta</b>	6	<b>3.13.4 Drum brake as wheel lock</b>	33
<b>1.7 Reception</b>	7	<b>3.13.5 Locking the wheel lock</b>	33
<b>1.8 Documentation</b>	7	<b>3.13.6 Rollback blocking</b>	33
<b>1.9 Service and Maintenance</b>	7	<b>3.14 Anti-tipper</b>	34
<b>1.10 Accessory and attachment drives</b>	7	<b>3.15 Back</b>	34
		<b>3.15.1 Setting the back angle</b>	34
<b>2 Safety Instructions</b>	8	<b>3.15.2 Adjusting the back angle</b>	34
<b>2.1 General Indications</b>	8	<b>3.15.3 Back extension submersible</b>	35
<b>2.2 Handling</b>	8	<b>3.16 Head rests</b>	35
<b>2.2.1 Getting in and out</b>	8	<b>3.17 Therapy table</b>	36
<b>2.2.2 Starting and slowing down</b>	9	<b>3.18 Abduction wedge</b>	36
<b>2.2.3 Danger of tipping and flipping over</b>	9	<b>3.19 Thorax truss pads</b>	36
<b>2.2.4 Up and downhill</b>	11	<b>3.20 Tipping lever</b>	36
<b>2.3 Changing seats independently</b>	12	<b>3.21 Cane holder</b>	36
<b>2.4 Grabbing objects</b>	13	<b>3.22 Outdoor Front End (push aid for outside)</b>	37
<b>2.5 Overcoming obstacles</b>	14	<b>3.23 Baggage holder</b>	37
<b>2.6 Wheel lock</b>	16		
<b>2.7 Anti-tipper</b>	16	<b>4. Repairs and Maintenance</b>	38
<b>2.8 Angle adjustable back and seat tilt</b>	17	<b>4.1. Repairs</b>	38
<b>2.9 Casters</b>	17	<b>4.2 Spare parts</b>	38
<b>2.10 Combination with electric push and brake aids and electric add-on drives</b>	18	<b>4.3 Disposal</b>	38
<b>2.11 Loading and Transporting</b>	18	<b>4.4 Tire change</b>	38
<b>2.11.1 Transport in public transportation</b>	18	<b>4.5 Maintenance</b>	39
<b>2.11.2 Transport in other vehicles</b>	18	<b>4.5.1 Cleaning and care</b>	39
<b>2.11.3 Attachment points</b>	19	<b>4.5.2 Disinfection</b>	39
<b>2.12 Other risks</b>	20	<b>4.5.3 Reinstatement</b>	39
		<b>4.6 Service/Inspection</b>	40
<b>3 Handling</b>	21	<b>4.6.1 Check list</b>	40
<b>3.1 Wheels</b>	21	<b>4.6.2 Check list yearly inspection</b>	40
<b>3.1.1 Quick release axle wheels</b>	21	<b>4.6.3 Service List</b>	40
<b>3.1.2 Drum brake wheels</b>	21	<b>4.7 Technical Data</b>	42
<b>3.1.3 Double hand rim</b>	21	<b>4.7.1 Measurements and dimensions</b>	42
<b>3.1.4 Transit safety wheels</b>	22	<b>4.7.2 Meaning of labels</b>	42
<b>3.2 Casters/steering head tilt</b>	23	<b>4.7.3 Technical data</b>	42
<b>3.3 Locking &amp; Track Fixation</b>	23	<b>4.8 DOCUMENTATION YEARLY INSPECTION</b>	43
<b>3.4 one-hand steering</b>	24		
<b>3.5 Special hand rims</b>	24		
<b>3.5.1 Knob hand rims</b>	24		
<b>3.5.2 Hand rim covers / Maxgrepp hand rims</b>	24		
<b>3.6 Folding and unfolding</b>	25		
<b>3.6.1 with seat and back covers</b>	25		
<b>3.6.2 with SeatFix and/or curved back plate</b>	26		
<b>3.7 Seat and back cover</b>	27		
<b>3.8 Firm seat plate (SeatFix) and curved back plate</b>	27		
<b>3.9 Push handles</b>	28		
<b>3.9.1 Pull-out push handles</b>	28		
<b>3.9.2 Push handles with push bar</b>	29		

## wheelchair overview

### Overview Jump beta - Sport frame

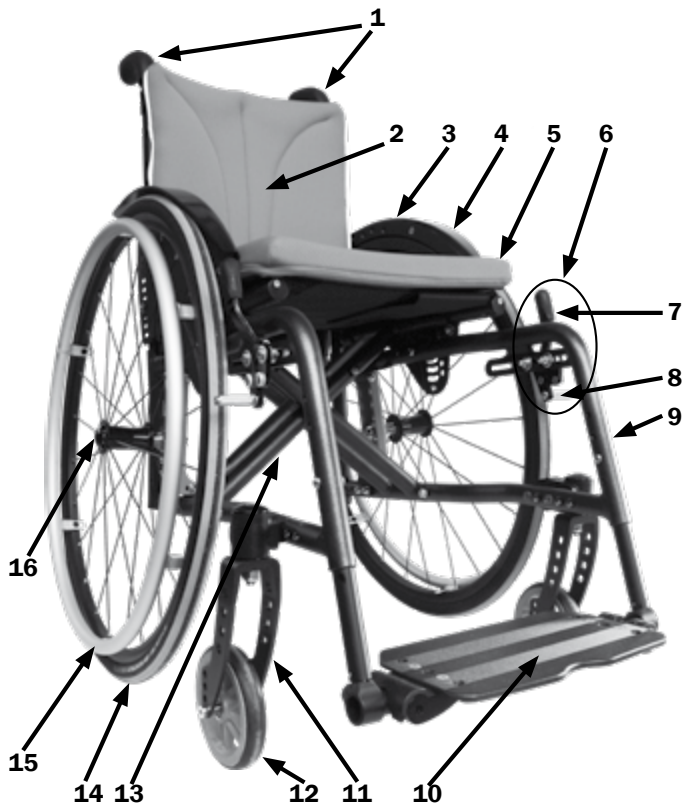

1. push handles
2. back
3. side guard
4. skirt guard
5. seat
6. locking brake (knee lever brake)
7. brake lever
8. brake bolt
9. Sport frame with built-in leg support
10. foot plate (continuous)
11. caster fork
12. caster
13. cross bar
14. driving wheel
15. hand rim
16. quick release axle

### Overview Jump beta - DLS frame

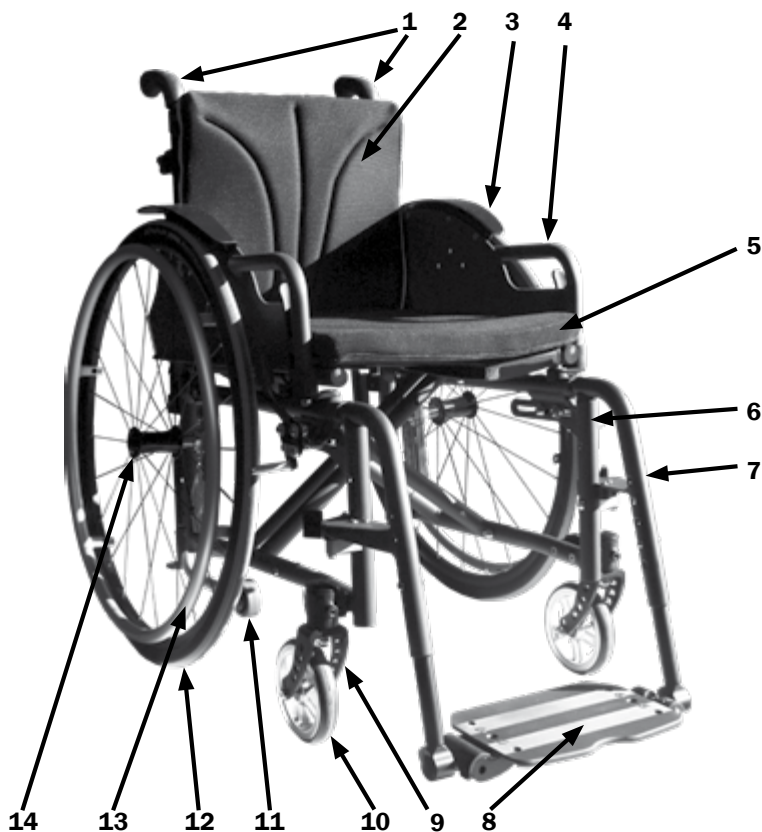

1. push handles
2. back
3. skirt guard
4. Desk-side guard
5. seat
6. locking brake (knee lever brake)
7. DLS frame with a leg support which can swing away and be completely detached
8. foot plate (continuous)
9. caster fork
10. caster
11. anti-tipper
12. driving wheel
13. hand rim
14. quick release axle

## 1 Preamble

### 1.1 General Information

The wheelchair has been built, adjusted and given to you operable according to your individual instructions. A qualified Technician will make any changes necessary, should modification be needed during use.

As any other aid, a wheelchair is a technical device that can hold risks if not properly used. This brochure is to help you familiarize yourself with the wheelchair and its functions.

#### ATTENTION

**Read the following instructions and manuals carefully.**

- User manual
- Info-brochure Crash Test ISO 7176-19

#### ATTENTION

**If the user of the wheelchair is a child or a person with limited competence, the parents or authorized supervisor have to make sure that they have fully understood the handling of the wheelchair before it is first used.**

If you have any questions your medical supply store or our competent team is glad to assist you (+49 07254/92790).

This user manual is directed to both you and your rehab technician. It contains instructions on the correct adjustments of Jump to your physical situation.

### 1.2. Signs and Symbols

#### ATTENTION

This is how **individual-related** safety aspects of **utmost importance** are indicated.

#### ▶▶ INDICATION

This is how possible **indications** of **utmost importance** are labelled.

#### INFORMATION

This is how INFORMATION on mounting and adjustment work is labelled.

#### READ

This refers to other chapters within the brochure or to additional material.

#### **BOLD PRINT**

Text in bold print highlights important passages or remarks.

### 1.3 Indication Jump beta

Because of its great spectrum of sizes, Jump beta is suitable for long term therapy laid out for many years. Thus, Jump is indicated for the following impairments (among others):

- (infantile) cerebral palsy,
- spina bifida,
- all kinds of palsy,
- all kinds of plegia,
- multiple sclerosis,
- all kinds of muscle weakness (myasthenia; atrophy or dystrophy),
- amputation of the lower extremities,
- cardiovascular insufficiency,
- rheumatic illnesses.

Jump supports the following therapeutic aims:

- preservation, development and/or strengthening of the patient's entire tonicity,
- stimulation, stabilization and strengthening of metabolism and circulation,
- preservation, development and/or strengthening of (auto-) mobility,
- stabilization and straightening of the patient's body (positioning),
- skeletal stabilization and strengthening of the spine,
- development and improvement of sensorial perception,
- participation in social surroundings (inclusion).

### 1.4 Counter indication Jump beta

#### ATTENTION

**Under the following circumstances and/or symptoms, please consult your doctor or therapist prior to any passive or active use of Jump:**

- Users whose skin is not intact (especially around the areas of buttocks, back, thighs, hands etc.) may experience dermatological complications (pressure marks, irritations, open traumata)
- if the user is suffering from grave tonicity deregulation
- patients with extremely impaired competence or perception CANNOT participate in road traffic without assistance.

#### ▶▶ INDICATION

**We are NOT liable for any damage to persons or objects resulting from using Jump under the circumstances stated above.**



## 1.5 Specification Jump beta

Jump beta is a lightweight, versatile activity wheelchair for indoor and outdoor use (apartment, school, workplace, leisure time, travels). It is equipped with **two different frame versions** with **two different leg supports**:

- firmly integrated with the frame (sports frame)
- or pivoting and removable (PLS frame)

Both frames are available with straight or abducted (6 cm) leg supports and two frame heights:

- standard height and
- XL height (+4cm)

Jump beta is suitable for children, adolescents and adults from a seat width of 28 cm and up to a maximum load capacity of 120 kg. Three frame sizes are available on the seat depth chosen:

- frame size 4 (for wheel sizes 22"/24")
- frame size 5 (for wheel sizes 24"/26")
- frame size XL (for wheel size 26")

Thanks to its **double cross-brace**, Jump provides freedom of twisting and driving comfort comparable to that of a wheelchair with a rigid frame. In order to support long term and sustainable therapy concepts, all equipment components are compatible with any frame version and may be converted or upgraded at any time. The wheelchair is perfectly adjustable to the user's physiognomic needs.

Jumps **seat/back area** provides various options, enabling a high differentiated positioning of the user:

- seat and back covers/belts,
- firm seat plate and firm molded back,
- anatomic seat/back unit,
- suitable for all kinds of seat shells (type 1-3)

**Casters** are available in various versions in sizes from 4" to 7".

The **side guards** are available in various versions as well: from welted aluminum (height adjustable) to retractable and pivoting versions, with or without **arm rest** (also height adjustable).

**Footrest/s** are available in both versions (inner or outer): divided or continuous. They all fold up and the sports frame version as well. For the DLS frame, a leg rest which can be elevated with physiological pivotal point and leg support are available.

Furthermore, Jump beta offers a wide range of equipment options (see order sheet).

## 1.6 Application

### **ATTENTION**

**The wheelchair serves solely to actively or passively transport the person to whom the wheelchair has been adjusted for by a qualified specialized trade.**

It can be used on firm ground without any restrictions indoors and outdoors. With suitable equipment (e.g. outdoor front end) the wheelchair can also be used on surfaces such as sand, cobblestones, gravel etc.

### **ATTENTION**

**The allowed load capacity (including seat shell) is not to be exceeded.**

### **ATTENTION**

**The wheelchair cannot be used in extremely wet surroundings (shower, sauna etc.) or salt water nor can it have excessive contact with moisture.**

### **ATTENTION**

**The wheelchair must not be used as means of transportation for goods, objects and the like.**

### **INFORMATION**

Regular maintenance and care (after chapter 4) is necessary for the guaranteed service life of the wheelchair.



## 1.7 Reception

### PLEASE NOTE DELIVERY

Each wheelchair is mounted, tested for functionality and correctness in our works and packaged into special cardboard boxes by our shipping experts.

### FORWARDING COMPANY

For liability reasons we have to ask you to check the wheelchair immediately after receiving it and in the presence of the deliverer (forwarding company) for possible damages that may have occurred during transportation.

### TRANSPORTAION DAMAGES

In case of damage, please proceed as follows:

- write a short record of the damage and review of events, if possible include pictures clearly showing the damage,
- get the personal information of the bearer (driver's license etc.),
- inform us immediately.

#### ▶▶ INDICATION

**Do not sign the notice of receipt from the forwarding company before thoroughly checking the wheelchair for defects.**

#### ▶▶ INDICATIION

**According to the valid law, damages reported late can neither be asserted to us nor to the forwarding company.**

## 1.8 Documentation

### INDICATION

**Keep this user manual in a safe place. Have all work/repairs done on your wheelchair documented by the medical supply store in the maintenance plan. If applicable, hand it back to your benefactor along with the wheelchair.**

#### ▶▶ INDICATION

**In the event of the wheelchair being reused, the service book is an important source of information for you benefactor. It provides evidence of regular inspections which might be relevant in the event of warranty claim.**

### ATTENTION

**For safety reasons have all repairs done and documented solely by a qualified specialized trade.**

## 1.9 Service and Maintenance

### READ

**According to § 33 subparagraph 1, clause 4, [German] SGB V, the responsibility of maintenance, repairs and replacement lies with the benefactor. After agreement with your benefactor, be sure to have all safety relevant inspections, maintenance work and if necessary repairs conducted in order to make the wheelchair functional.**

### ATTENTION

**Be careful with all moveable parts since there is a RISK of crushing fingers and other body parts.**

### ATTENTION

**The regular inspection of all safety relevant parts on the wheelchair by a qualified rehab workshop is the only way to prevent damages and maintain our liability.**

### ATTENTION

**Only original parts are to be used for all service and maintenance work.**

### INFORMATION

Proceed according to the maintenance plan in chapter 4 of this user manual.

## 1.10 Accessory and attachment drives

### ATTENTION

**The addition of these accessory and attachment drives is done by either the manufacturer or the sanitary house and solely in their responsibility**

### INFORMATION

Ask the manufacturer for the respective requirements.

## 2 Safety Instructions

### 2.1 General Indications

**⚠ ATTENTION**

The risk of injuries is on all rotatable and turnable parts. This also goes for adjustment and repair work.

**⚠ ATTENTION**

The wheelchair can only be used according to its specifications. Any other use or misuse can contain serious risks for you and your surroundings. Also the guarantee or product liability can be terminated in case of misuse.

Slowly familiarize yourself with the wheelchair at the first use and after adjustment work has been done. First practice on level grounds with the help of an experienced person. Only then are you allowed to try uphill and downhill with the help of an experienced person.

From putting on and taking off the accessories, the measurements of the wheelchair, its weight, the handling and tilting changes.

**⚠ ATTENTION**

A strong seat inclination plus a very active rear wheel position plus unfavorable posture can cause tipping over even on a flat surface.

**⚠ ATTENTION**

All mounting alterations on your wheelchair must be coordinated and made by the manufacturer or your rehab technician.

**⚠ ATTENTION**

Do not make any adjustments, repairs and/or do maintenance work yourself. Contact your qualified medical supply store.

**📖 READ**

Consider the indications for maintenance and inspection on your wheelchair at the end of the operating instructions.

### 2.2 Handling

#### 2.2.1 Getting in and out

**⚠ ATTENTION**

(1) Getting in and out can only occur on a flat surface and with **ACTIVATED WHEEL LOCK**.

Activate the tilt safety for each transfer and always turn the caster forward in order to enhance the stability.

Let someone help you getting in and out if possible/necessary. Let the helping person know of possible hazards such as tripping, edges and your degree of disability.

**⚠ ATTENTION**

(2) **NEVER** use the footrest/s to get in and out. The wheelchair can tip forward. Please fold (when possible) the footrest/s to the side or to the back in order to get closer to the wheelchair.

**▶ INDICATION**

(3) For some children it is asked for, therapeutically, that they get in and out on their own by using the footrest. In this case consider the following:

- turn casters forward,
- secure the wheelchair from rolling away,
- activate tilt safety,
- don't let the child get in and out unattended,
- be ready to give assistance.





## 2.2.2 Starting and slowing down

### ⚠ ATTENTION

Avoid jerky starts. The wheelchair could tip backwards. Thus, when possible, lean your upper body forward when starting. With children we always recommend to use the tilt safety whenever possible.

### ⚠ ATTENTION

While driving, braking occurs through controlled pressure applied to the hand rims from your palms/fingers. Please keep in mind that you require more strength in order to brake going downhill. When driving downhill make sure to drive slow enough that you are able to bring the wheelchair to a full stop at any time.

### ⚠ ATTENTION

Also keep in mind that the hand rims heat up from friction (especially hand rims with a cover).

### ⚠ ATTENTION

If necessary, use gloves with a leather inner surface as used by cycling, but NEVER wool gloves.

## 2.2.3 Danger of tipping and flipping over

### ⚠ ATTENTION

Generally the hazard of flipping and tipping occurs (also see pictures on the next page)

- (1) from all kinds of height differences of the ground surface,
- (2) from stairs (never manage alone),
- (3) from participation in public traffic under the influence of medication, drugs, alcohol, etc.,
- (4) when driving up hill and/or the emphasis of different objects on the back of the wheelchair,
- (5) when leaning out of the wheelchair,
- (6) from longitudinal grooves such as street-car rails (hazard of getting stuck). Always cross at a 90° angle.

(1)



(2)

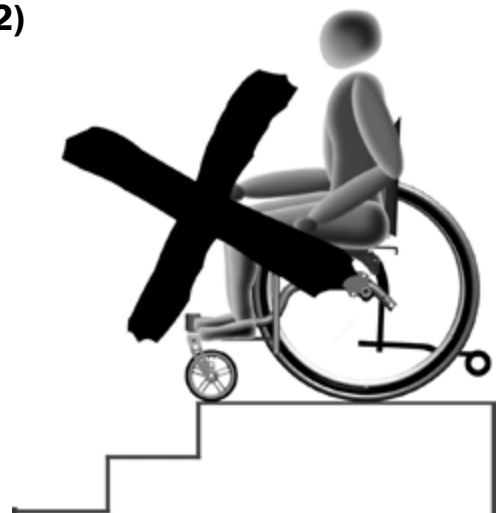

(3)



(4)



(5)



(6)

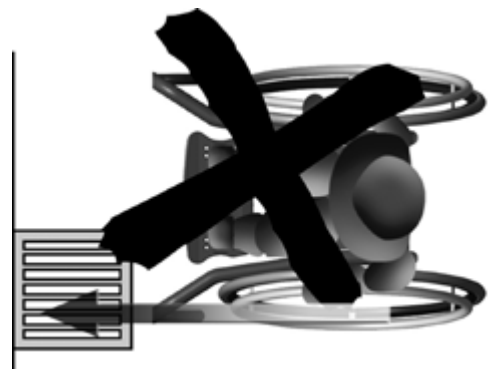
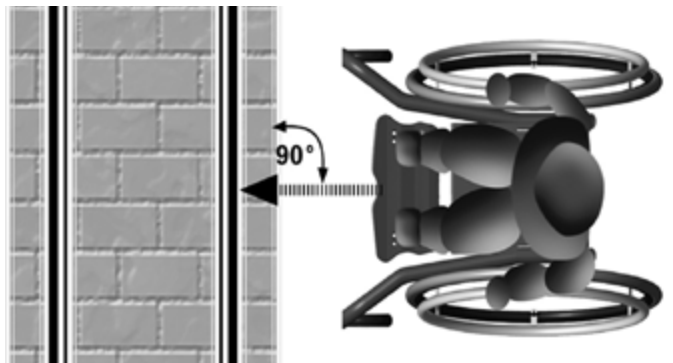
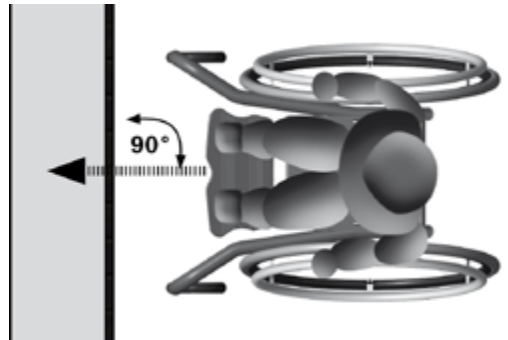
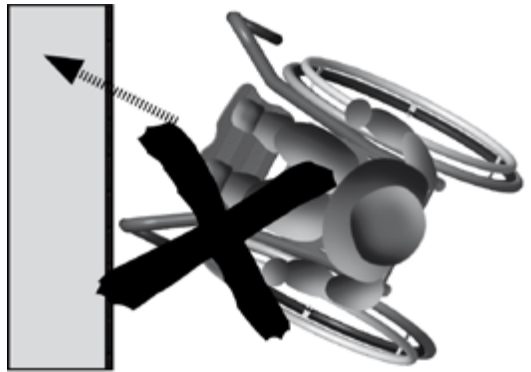

### 2.2.4 Up and downhill

**⚠ ATTENTION**

Keep in mind the higher strain in order to drive or brake going up or downhill (see 2.2.1).

**⚠ ATTENTION**

(1) If possible, tilt your upper body, when driving up or downhill, in the direction of the hill.

**⚠ ATTENTION**

Only go up ramps or hills with an incline or descent greater than 6% with assistance.

**⚠ ATTENTION**

NEVER go on ramps or hills WITHOUT the anti-tipper activated.

**⚠ ATTENTION**

(2) NEVER drive on inclines, descents or curbs sideways to the road, you may tip over.

(1)

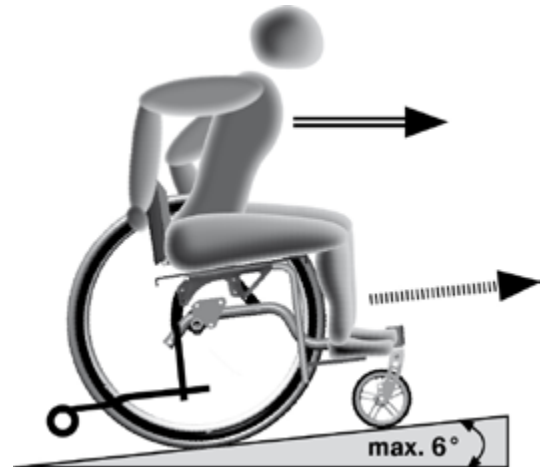
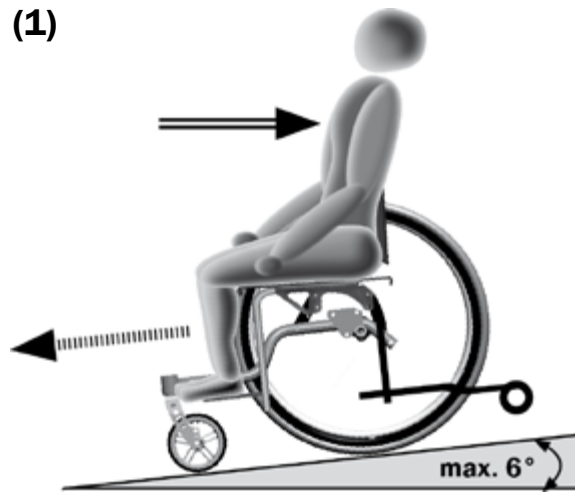

(2)



### 2.3 Changing seats independently

**⚠ ATTENTION**

Changing seats independently is dangerous and requires experience. Practice this first with the help of a carer, before you change seats by yourself.

**⚠ ATTENTION**

The footrests are located in the leg area, whereby the danger of tripping can occur! Make sure that the footrest is NOT in the maneuver area! Otherwise, change the transfer side if possible. Fold the footrest/s, if possible, away or flip the leg support/s out.

**(1)** In order to transfer independently drive as close as possible (forwards or in a 45° angle) to the other seating area and assure yourself of the firm fixation. If possible, flip the side part back. Lock the wheel lock and hold on to the new, nonslip seat

**(2)** It is an advantage to have a nonslip board or a similar device. Make sure that the nonslip board is securely on the surface and can't slip around itself and proceed as already described.

**(1)**



**(2)**



## 2.4 Grabbing objects

Carefully test the tilt behavior of the wheelchair to the side, front and back **with the help of an experienced and strong helper**.

### ATTENTION

**(1) Do not grab objects behind the wheelchair reaching over the back of the chair, DANGER OF FLIPPING OVER.** Turn the wheelchair around and go towards the object from the front or the side.

### ATTENTION

In order to grab objects from the side/in front of the wheelchair secure the wheelchair from rolling away! Do not lean too far out of the wheelchair.

### ▶ INDICATION

Generally, using a reacher is safer.

**(2)** If possible, when leaning out of the wheelchair sideways, hold on to something on the opposite side with your free hand and try not to shift too much weight.

**(3)** If you have to lean forward out of the wheelchair, **NEVER** strain the leg supports, **DANGER OF FLIPPING OVER!** First turn the casters forward for better positioning.

In addition, (if possible) put both feet on the ground, preferably as far from you as possible. Here you are generally on the safe side if you use a reacher. Your medical store will gladly advise you.

**(2)**



**(3)**



**(1)**

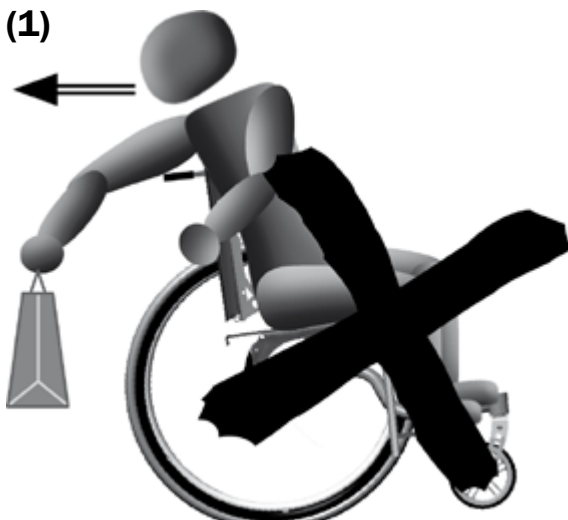



## 2.5 Overcoming obstacles

### **⚠ ATTENTION**

**A WHEELCHAIR IS NOT FOR CARRYING. IT WAS NOT DESIGNED NOR TESTED OR BUILT FOR THIS:**

**For this reason avoid stairs whenever possible! Instead to overcome height differences use ramps or elevators.**

### **⚠ ATTENTION**

**(1) NEVER overcome stairs etc. with the wheelchair ALONE.**

### **⚠ ATTENTION**

**(2) Only overcome stairs with the help of two experienced people. For this, the anti-tipper must be deactivated. Be sure that the wheelchair is only held by metal parts which are screwed securely to the frame.**

### **⚠ ATTENTION**

**(3) NEVER PULL OR CARRY THE WHEELCHAIR OVER AN OBSTACLE BY THE REMOVEABLE SLIDING HANDLE OR THE PUSH HANDLE.**

### **⚠ ATTENTION**

The plastic caps on the push handle can loosen due to adverse conditions (heat, precipitation, heavy strain etc). Inform your carer of the dangers.

### **⚠ ATTENTION**

The same goes for the removable leg support, foldable desk side guard and/or foot rests.

### **⚠ ATTENTION**

Do not under any circumstances use escalators, not even with a carer. Shopping malls and public building with escalators always have elevators as well.

(1)



(2)



(3)

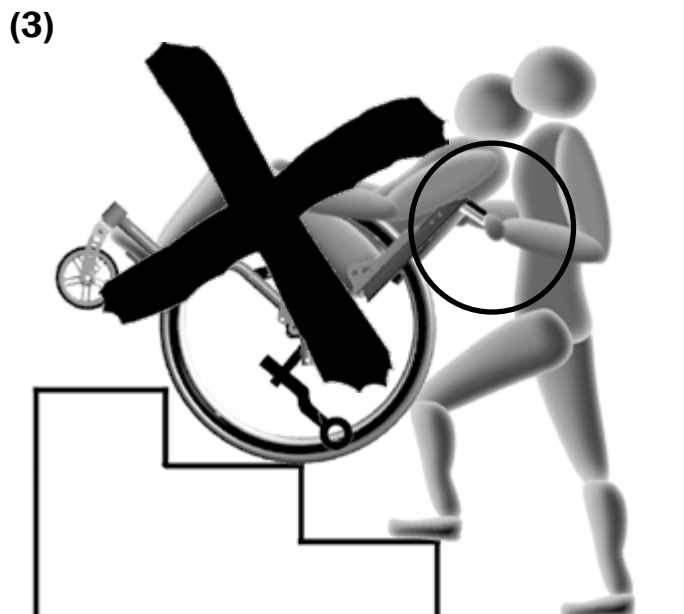

**⚠ ATTENTION**

**Do not drive towards, for example, curbsides without braking, DANGER OF TIPPING OVER!**

**⚠ ATTENTION**

**(1) In order to overcome height differences or when using an elevator and lifting platforms, you generally have to deactivate the anti-tipper. You could become restricted in maneuverability.**

**(2) In order to overcome curbsides your carer should slightly tilt you backwards, lift both casters over the threshold and then, with the rear wheels, carefully push the wheelchair over the edge-**DO NOT LIFT**. The anti-tipper must be deactivated.**

**(3) When driving off of the curb please proceed correspondingly.**

**⚠ ATTENTION**

**For this, the casters must stay in the air until the rear wheels are over the threshold. **DO NOT** put the caster down first, **DANGER OF FLIPPING OVER**.**

**(4) Practiced drivers can overcome curbsides with the so called wobbling without someone's help. Slowly and with the help of a carer familiarize yourself with this technique.**

**⚠ ATTENTION**

**This maneuver requires a lot of practice and control over the wheelchair!**

- **Drive** slowly in a 90° angle up to the spot you want to overcome and wobble the wheelchair slowly backwards so that the casters do not have contact to the ground.
- **Bring** the casters hanging in the air over the threshold/edge and drive the wheelchair up to the obstacle.
- **Drive** over the threshold/edge with your upper body leaning forward as far as possible and put the casters down on the ground after.

**(1)**



**(2)**



**(3)**

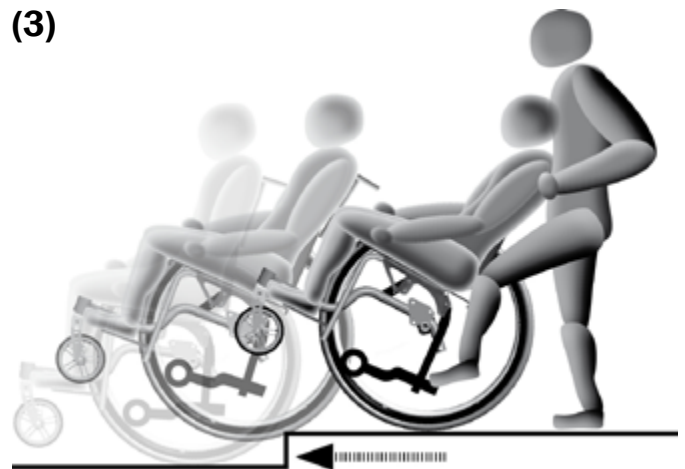

**(4)**

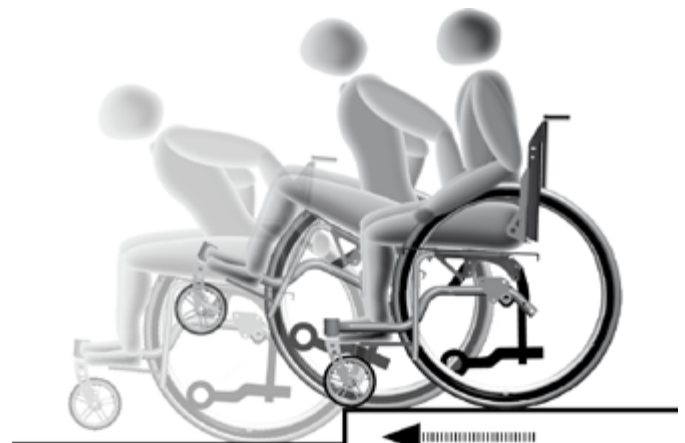

## 2.6 Wheel lock

### **⚠ ATTENTION**

The knee lever brake is a wheel lock and **NOT** designed to brake during the drive. While driving, (especially downhill) you could bring the wheelchair to a sudden full stop, whereby you could fall out of the wheelchair. A service brake, such as a drum brake, allows controls braking.

### **⚠ ATTENTION**

Before each drive make sure to check

- the correct tire pressure (information is on the outer tire)
- and if necessary the brake pressing bolt
- and if necessary the cable controls

### **⚠ ATTENTION**

Cable controls are high maintenance! Especially the clamp screws and the Bowden cable need to be checked on a regular basis and retuned if necessary. These cable controls are used for:

- Drum brakes
- Cable brake (integrated in the side guard)
- One hand brake
- Accompany brake (only by older models).

### **⚠ ATTENTION**

The reverse gear stop is effective on an incline of max. 12,3% (=7°) with a load (passenger incl. seat shell or similar) of up to 90 kg.

### **⚠ ATTENTION**

Regularly remove lint and dirt from the brake bolts.

### **⚠ ATTENTION**

Keep in mind that dirt, wetness, ice, snow, mud etc. can impair the brake force of the wheel lock.

### **⚠ ATTENTION**

Do not make repairs on the wheel lock yourself. Ask your rehab technician.

### **⚠ ATTENTION**

After all changes on the rear wheels (position of the axle plate, tire changing) the functionality of the wheel lock must be checked and if necessary newly adjusted.

## 2.7 Anti-tipper

### **⚠ ATTENTION**

We recommend inexperienced and young users to use the anti-tipper whenever possible.

### **▶▶ INDICATION**

Additionally, each one of our wheelchairs can be equipped with anti-tippers.

**(1)** In order to independently activate the anti-tipper you must secure the wheelchair from rolling away, slowly reach behind you without leaning too far out of the wheelchair, push the anti-tipper down and turn it 180° on its own axis until it snaps back into the guide slot. If possible hold with your other hand on to the rear wheel/hand rim on the opposite side:

### **⚠ ATTENTION**

**(2)** When overcoming height differences or when using elevators or lifting platforms deactivate the anti-tipper. You could become restricted in maneuverability.



**(2)**



## 2.8 Angle adjustable back and seat tilt

### **⚠ ATTENTION**

(1) With an angle adjustable back or seat tilt the anti-tipper is to be activated starting from a setting of 90°.

### **⚠ ATTENTION**

For active use the back or seat tilt must be in an upright (90°) position.

Make sure that when adjusting the back angle or when tilting that the head has enough support from for example a head rest.

### **⚠ ATTENTION**

**NEVER** activate the seat tilt or the angle adjustment while driving.

### **▶▶ INDICATION**

(2) In the case of amputations or leg elevation and simultaneously “leaning back”, we recommend for improvement of the tilt stability a wheel base elongation, at least the use of an anti-kipper.

### **⚠ ATTENTION**

A wheel base extension is strictly **NOT** a replacement for an anti-tipper!

## 2.9 Casters

### **⚠ ATTENTION**

Casters which are not correctly adjusted or driving too fast, especially downhill, can cause the casters to dangerously flap back and forth.

### **▶▶ INDICATION**

Clean the axes and the axle holder regularly, removing lint and dirt.

### **i INFORMATION**

After every change on the rear wheels the casters must be newly adjusted. Let this be done by an experienced rehab technician.

### **▶▶ INDICATION**

(3) When transferring in and out of the wheelchair turn the casters forward for greater stability by slightly moving the wheelchair backwards.

(1)

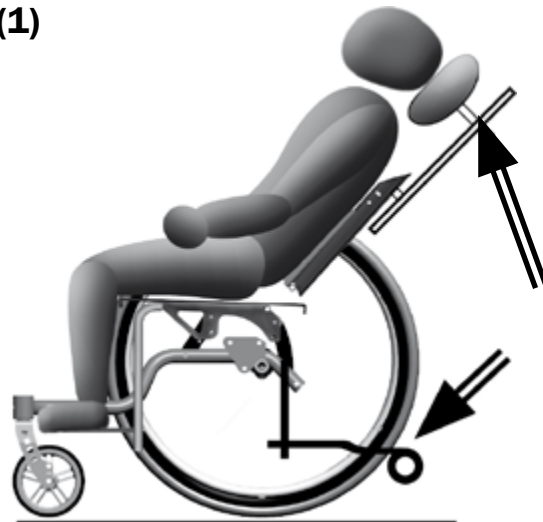

(2)



(3)





## 2.10 Combination with electric push and brake aids and electric add-on drives

### ATTENTION

The wheelchair can only be combined with the electric push and brake aids and electric add-on drives that are explicitly cleared by SORG Rollstuhltechnik. Thereby restrictions or adjustments of the mounting on the final configuration of the wheelchair apply to the supplier of the add-on drives.

### ATTENTION

Please follow the instruction manual of your electric push and brake aid or your electric add-on drive. In combination with your wheelchair specific strains occur which can otherwise cause damage to your wheelchair.

### ATTENTION

If possible, overcome curbsides/obstacles backwards (with the large driving wheels first). Should this not be possible: drive slowly toward the obstacle and overcome it carefully.

### ▶▶ INDICATION

Please note the safety instructions stated in chapter 2.5 overcoming obstacles.

## 2.11 Loading and Transporting

For the transport of your wheelchair in a car please consider the following points:

- If necessary flip the anti-tipper inwards.
- If necessary remove the push handle/s or handle bars.
- If possible remove the hollow molded back and fold the back down.
- If possible fold the wheelchair and close it securely with the folding fixture strap.
- Unlock the wheel lock and remove the rear wheels.
- Secure the wheelchair with tension belts in the vehicle.
- The tension belts can only be secured on fixed frame parts. Foot rests, side guards, back or seat adapters are not suitable for this.
- Secure all removed parts of the wheelchair in the vehicle so that they cannot hurt anyone in case of sudden braking.

### ATTENTION

There is a risk of getting hurt from loose, flying objects such as leg supports, seat shells, wheels, sticks, bags etc.

Inform yourself by your car salesman about safely securing the wheelchair with lashing exes or other suitable safety measures in your vehicle before transporting the wheelchair.

### 2.11.1 Transport in public transportation

In every public transportation a spot must be provided to place the wheelchair according to the EG-guideline 2001/85/EG.

### ATTENTION

The spot in public transportation is only arranged for EMPTY wheelchairs.

### ATTENTION

Place the wheelchair in the provided area opposite the driving direction so that the backrest and a side guard rest securely on the edge of the provided area.

- The wheelchair is not allowed to shift in case of an accident, close the wheel lock.
- During the drive leave the wheelchair and seat yourself in the provided seat next to the spot for your wheelchair.
- If available, use the seat belt!

Let someone help you get in and out of the public transportation,

- so that you don't get stuck in the crack between the door and the sidewalk,
- so that you don't panic
- so that your claim for the marked seat possibly gets more emphasis,
- so that you can be helped getting into the seat and tying down the wheelchair.

### 2.11.2 Transport in other vehicles

Wheelchairs can never reach the stable features of a firmly mounted car seat because of their purpose and light build.

### ATTENTION

Thus, we recommend you to NOT use the wheelchair as a seat while transporting in a vehicle.

### READ

Read our info brochure "Crash Test ISO 7176-19". Here, the potential dangers and regulations of the ISO 7176-19 are described.

### ATTENTION

Only wheelchairs that have successfully passed a dynamic crash test according to ISO 7176-19 are allowed to be used as a seat in a vehicle.



Our successfully tested wheelchairs are provided with this international symbol on the type sign and are additionally marked on our order form with our “crash If necessary, inform yourself by your retailer or under [www.sorgrollstuhltechnik.de](http://www.sorgrollstuhltechnik.de), if your model is approved as a seat in a vehicle.



### 2.11.3 Attachment points

#### **⚠ ATTENTION**

(1+2) When using the Vector in a vehicle as a seat, only the attachment points with an international anchor symbol (A) can be used for the belts

- (1) back left and right
- (2) front left and right

#### **⚠ ATTENTION**

(3) Be sure that all four belts of the wheelchair back restraint system (B) are tight according to the manufacturers specifications.

#### **⚠ ATTENTION**

It is necessary to use a head rest! We recommend one which is independent from the wheelchair and firmly attached in the vehicle.

When using a head rest which is attached to the wheelchair, a second stabilizing rod may be necessary. For this please read the regulations and instructions in our info brochure “Crash-Test ISO 7176-19”. You can download these at [www.sorgrollstuhltechnik.de](http://www.sorgrollstuhltechnik.de).

#### **⚠ ATTENTION**

(4) Be sure that the patient in the wheelchair is secured with at least a 3 point belt (C) according to the specifications of the manufacturer for person restraint systems.

#### **⚠ ATTENTION**

Be sure that the chest belt goes over the sternum and does not touch the neck.

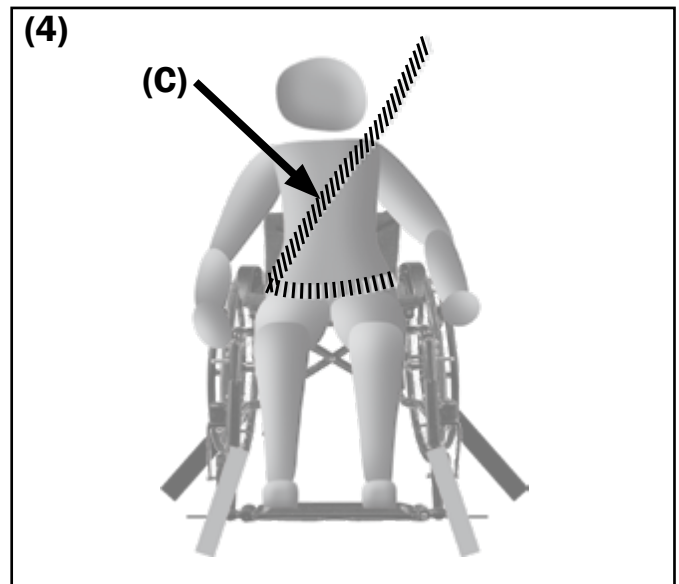
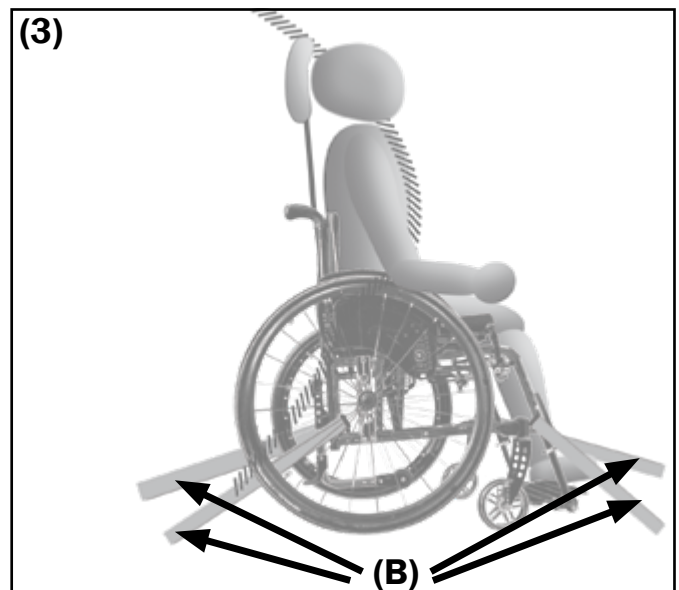
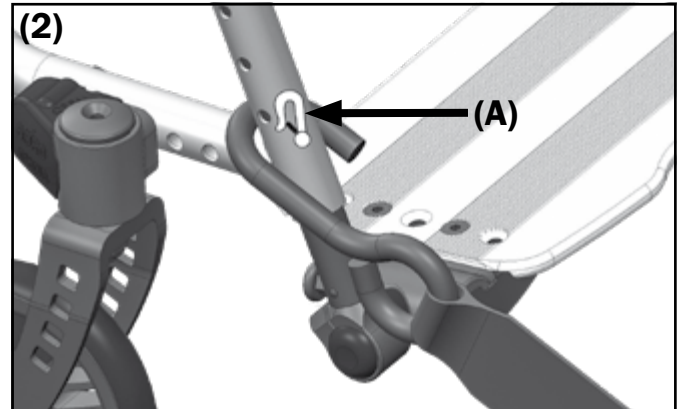
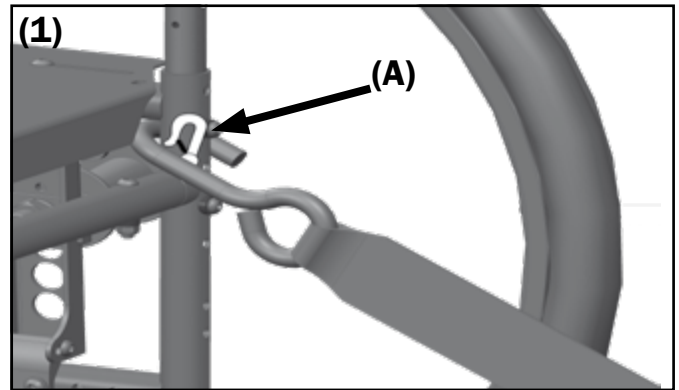

## 2.12 Other risks

### **ATTENTION**

After a collision, contact your rehab service station to check the carriage, frame and Bowden cables and have the damages fixed.



### **INDICATION**

Avoid direct sun rays. Dark parts on the wheelchair can heat quickly and can possibly cause burns. The wheels can heat up to 42° and you could burn yourself.

### **ATTENTION**

**FIRE RISK** from the textile parts (seat shell and back covering, seat cushion or plastic parts). Keep sources of ignition away from the wheelchair. The extent of the reliability against ignition of textile materials and assembly groups has been tested and standardized according to DIN EN 1021-1 and 1021-02.

### **ATTENTION**

Hand rims heat up from strong friction especially from braking while driving fast or from driving downhill for a while. If necessary, use leather gloves as used for cycling, **NEVER** use wool gloves.

### **INDICATION**

For sensitive skin we recommend to wear gloves as used for cycling (finger stalls with a leather inner surface—but **NEVER** wool gloves).

### **ATTENTION**

**RISK OF HAND INJURY** from turning parts. Do not grab in between the spokes of the rear wheel or between the rear wheel and the knee lever brake.



### **INDICATION**

Do not use the wheelchair in damp rooms or drive in salt water with it. Important parts may corrode and not work properly anymore, whereby the driving qualities or the lifespan of the wheelchair are negatively influenced.



### **ATTENTION**

The position of the rear wheels in the axle plate can only be changed by a qualified specialty store!

### **ATTENTION**

Do not put your fingers between the hand rims and the rear wheels. (Grooved wheels with built in hand rims make this impossible.)

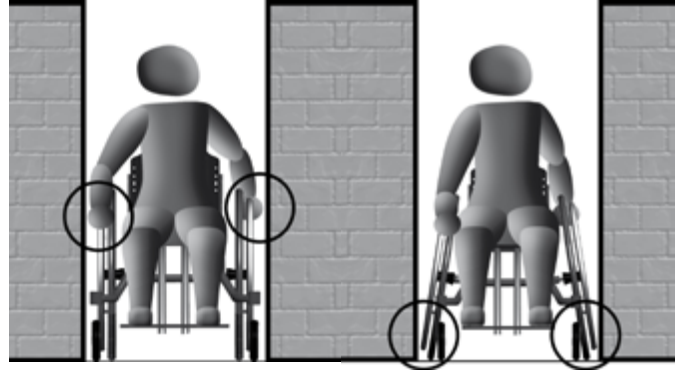

### **ATTENTION**

Be cautious by tight spots: You can bruise your fingers and/or damage the hand rims.

### **ATTENTION**

Check the secure position of the spokes regularly according to the maintenance plan.

### **ATTENTION**

Check the screwing and the secure position of the hand rims regularly according to the maintenance plan.

### **ATTENTION**

In certain cases it can occur that the product can cause an interaction with an electromagnetic field (e.g. security systems of stores etc.). There is no danger for the user and/or the attendant from this.

### 3 Handling

#### 3.1 Wheels

##### 3.1.1 Quick release axle wheels

All of our rear and 12" wheels are equipped with quick release axles for fast removal.

**(1)** To release or apply the quick release axle, push the lock button **(A)** in the middle of the wheel nub and release it after the action.

**(2)** After applying, the lock ball **(A)** must be completely in sight at the end of the quick release axle. The wheels should not be able to be removed.

Be sure to regard the following points:

- Wheels are turning parts and can cause injuries to fingers.
- After fastening the wheels, check the secure hold of the quick release axle.
- **(2)** Check the small lock ball (tension spring) **(A)** at the end of the quick release axle to be sure it functions properly.
- Check the air pressure of the rear wheels regularly, in order to ensure the functionality of the brakes!

With camber of wheels the toe in can be corrected if needed (see service record under "track alignment").

#### **⚠ ATTENTION**

**It is absolutely necessary that you let your rehab technician do the required work.**

##### 3.1.2 Drum brake wheels

To apply or remove please proceed as described with the rear wheels.

#### **ATTENTION**

**The drum brake wheels' brake pads are extremely sensitive and can lose their functionality from dirt or scratches on the brake pads. Remove lint and dirt from the brake pads regularly with a soft brush. Check the functionality of the Bowden cables regularly, in short intervals.**

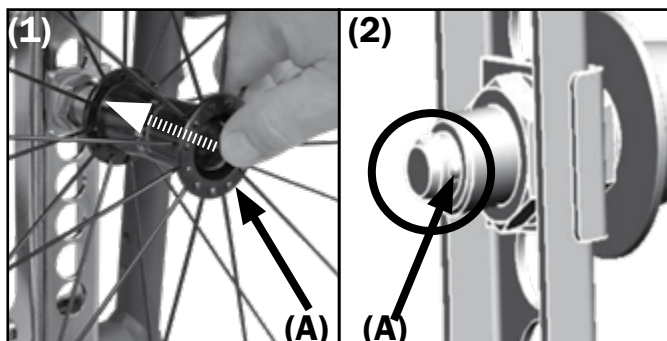

##### 3.1.3 Double hand rim

Moving a wheelchair with a dual hand rim requires a lot of practice. Familiarize yourself, with the help of an experienced carer and in familiar surroundings, with the technology of this type of particular way of driving.

**(3)** When transporting etc. remove the telescopic tube **(A)** by pushing both ends together. Unlock **(B)** the rear wheels and remove them.

**(4)** To set them back on proceed in the same way and pull the telescopic tube over the wheel axle **(C)**. Make sure the seat is correctly secured in place.

Before reusing the wheelchair the lock **(B)** must be activated.

#### **⚠ ATTENTION**

**To brake you must apply the same pressure to the hand rims (inside and outside), otherwise you will swerve unwillingly and become a hazard to yourself and your surroundings.**

#### **⚠ ATTENTION**

**Especially when driving downhill, make sure that you are able to bring your wheelchair to a stop at any time or have someone help you.**

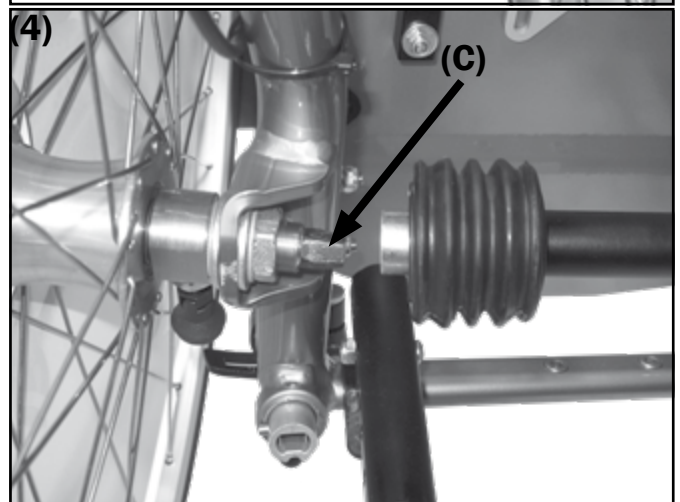
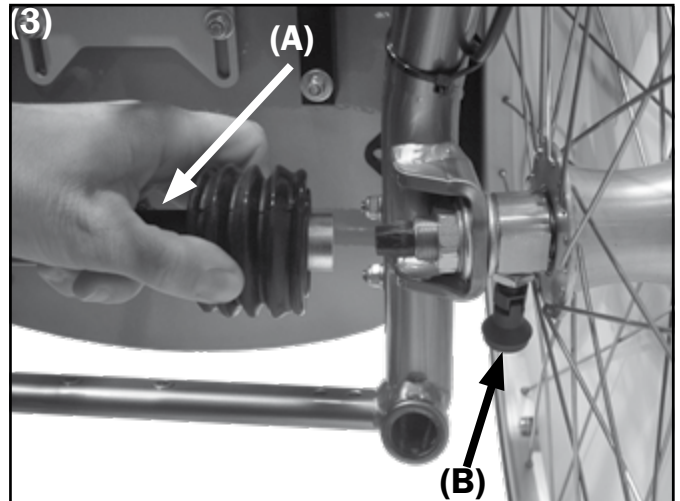



### 3.1.4 Transit safety wheels

(1) The Transit safety wheels (TSW) save and elaborate change, reseating, mounting on and off when getting in to a bus, train, airplane, bath room etc. You have three functions that correspond with the holes:

- (A) inactive anti-tipper
- (B) active ant-tipper
- (C) Transit wheels

#### **⚠ ATTENTION**

**Changing to and from the Transit mode can only happen on even grounds since the wheel lock is useless without the rear wheels.**

**In the Transit mode both TSW have to be firm in the bottom hole of the disc (1,C). When you are securely on both Transit wheels and both rear wheels can freely move, you can remove the rear wheels.**

**When transferring from tight spaces there is a RISK OF BRUISING fingers1**

#### **Use**

(2) To bring the TSW from the inactive position to the anti-tipper position loosen the red levers on both sides (1,D).

Let the TSW glide down until they are tightly snapped in to the middle hole (1,B) of the hole plate.

(3) In order to use the TSW as transit wheels unlock both wheels with the red levers (1,D) and let the TSW glide down to the ground (the lever cannot snap in to place in this position!).

Jack up the wheelchair (about 1 cm) by having your accompanying person put a foot behind the wheel as resistance and simultaneously pulls the wheelchair towards him. The red levers automatically snap into place in the bottom position (1,C). If the rear wheels can freely move (4) you can remove it.

Alternatively to this, you can independently, sitting in the wheelchair, with a jolt of the pelvis to the left/right relieve and lift the respective side so that the TSW can snap in to the bottom position. Remove the wheels and pass through the tight space.

After, attach the rear wheels and unlock the TSW with the red lever (1D). The wheelchair will sink about 1 cm and stands on its "own" wheels.

Bring the TSW in the wanted inactive (1A) or anti-tipper position (1B) by guiding the wheels up, while pushing the red levers, until they snap in to the wanted holes.

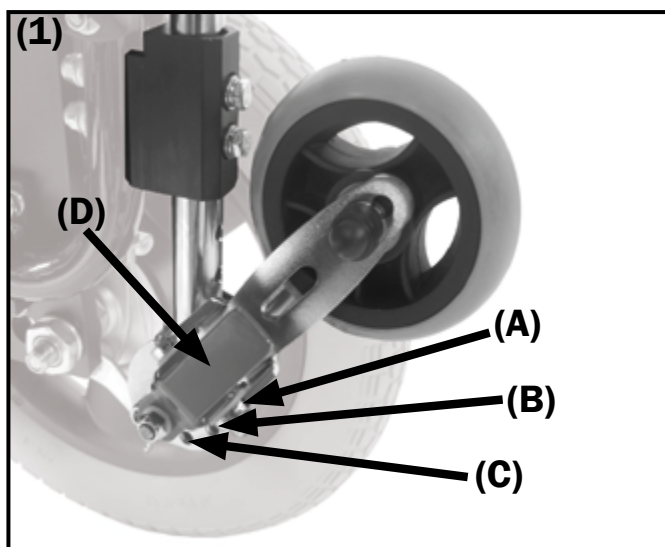

### 3.2 Casters/steering head tilt

#### **⚠ ATTENTION**

**By all means avoid a collision with a curb side or the like!**

**After a collision a qualified retailer must immediately check the wheelchair for possible damages and if necessary make repairs.**

**At the first sign of the caster shaking (especially during fast drives or on slopes) slow down.**

#### **caster exchange rate**

For casters with exchange rate proceed as with the quick release axles of the rear wheels.

#### **replacement/displacement**

The casters can be displaced in the caster fork through alternative hole positions or completely replaced.

The necessary installation work is described in 2.3.2 of the service record.

#### **steering head tilt**

**(1)** In the steering head **(A)** is the caster fork **(B)**. It must be in a vertical position ( $90^\circ$ ) to avoid caster flapping etc.

The tilting of the steering head can be adjusted/set. The necessary work is described in 2.3.2 of the service record.

#### **⚠ ATTENTION**

**When reinstating the quick release axle make sure that it has a firm fit! The pushed in button must be completely visible afterward (see quick release axle rear wheels).**

**Caster axles, caster forks and quick release axles should be freed from lint and dirt regularly.**

#### **⚠ ATTENTION**

**Through changes on the rear wheels and/or casters the centre of gravity can change and/or a flapping of the caster can occur. Through this they can block and the wheelchair can tip over.**

**This is why after every change on the rear wheels and/or casters the steering head tilt must be newly adjusted.**

### 3.3 Locking & Track Fixation

**(2)** In order to **unlock** the track fixation, pull the locking bolt **(A)** forward and turn it  $90^\circ$  so that it clasps in the lock groove **(B)**.

**(3)** In order to **lock** the track fixation, pull the locking bolt **(A)** a little more forward, turn it  $90^\circ$  and let it slide into the guide slot **(C)**.

At the next turn of the caster the bolts will automatically clasp into a forward position and lock them from driving straight ahead.

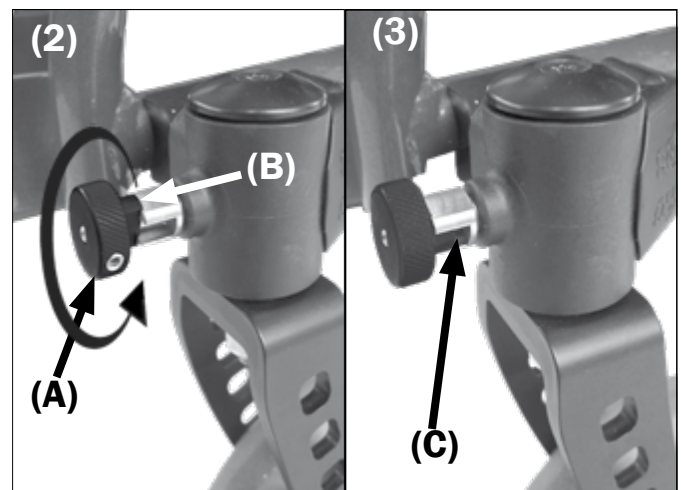
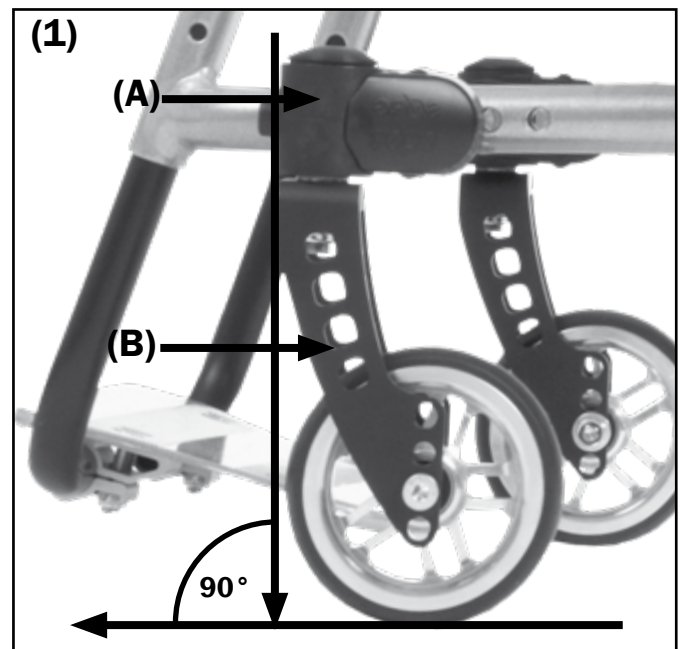



### 3.4 one-hand steering

To set the position of the steering lever:

- (1+2) push the safety clamp (A) up,
- (3) remove the steering lever (B) by pulling it up,
- (4) choose the wanted position along the notch (C),
- push the steering lever (B) back down and secure it in the safety clamp (A) as in (1).

To activate the one hand steering (OHS):

- turn the casters straight forward (only this way can the OHS be activated or inactivated),
- (5) unlock the snapping mechanism (A) (pull the lock (B) out and turn it 90°)
- (6) push the complete mechanism (A) down until it snaps into place and relock the mechanism.

To inactivate the one hand steering please proceed analog.

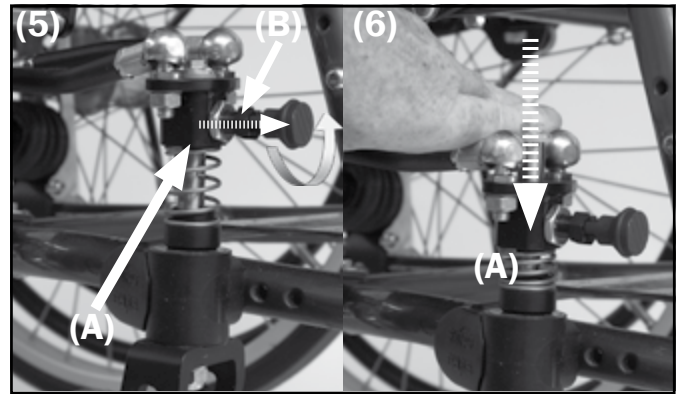
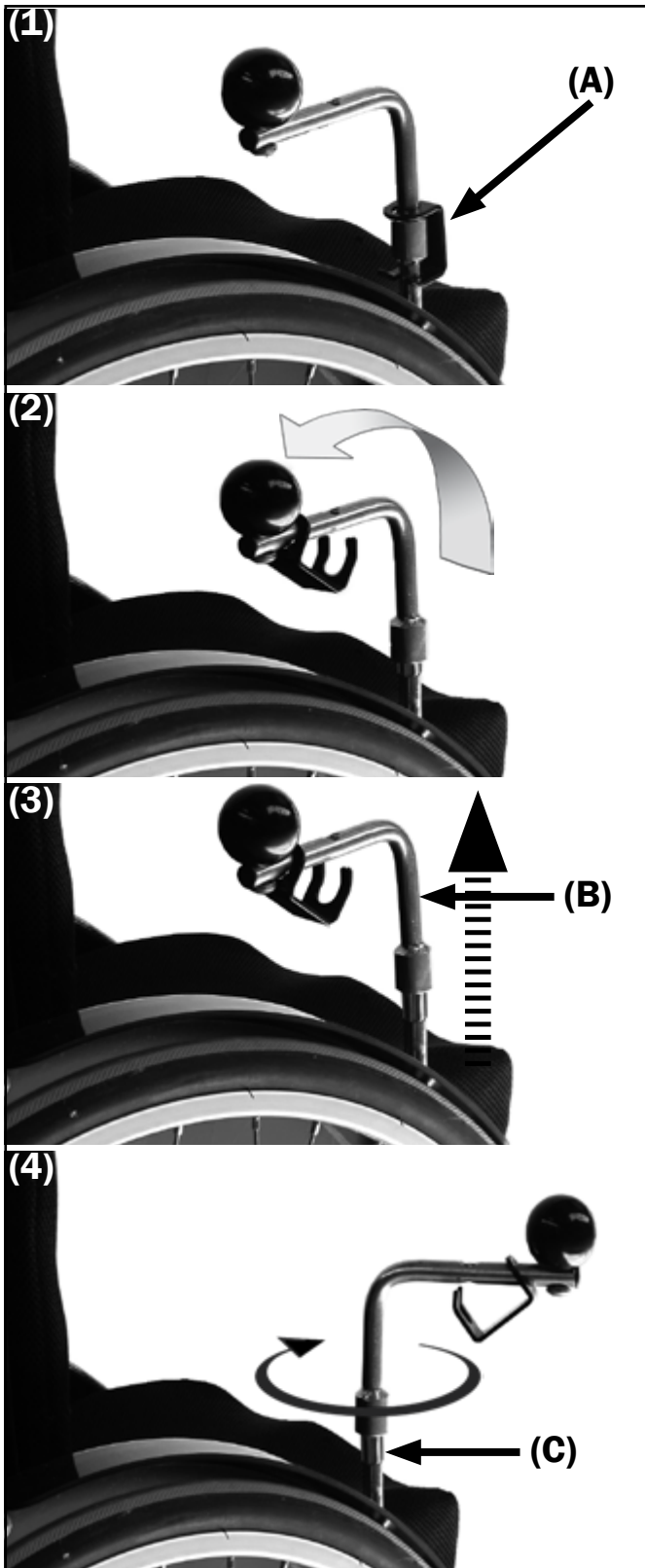

### 3.5 Special hand rims

#### 3.5.1 Knob hand rims

#### ⚠ ATTENTION INJURY RISK!

Regard that the knob hand rims turn when you are being pushed!

#### ⚠ ATTENTION

Braking with pressure on the hand rims is not possible. This applies especially when driving downhill. Let an experienced and strong carer assist you.

#### 3.5.2 Hand rim covers / Maxgrepp hand rims

#### ⚠ ATTENTION

All hand rim covers and the Maxgrepp hand rim are made out of several black synthetic materials and can heat to over 42° in the sun.

Under unfavorable circumstances the black coating can stretch from the heat and can detach from the hand rim.

For braking from high speed and/or when driving downhill wear appropriate leather gloves or, if necessary, let someone help you.

### 3.6 Folding and unfolding

#### 3.6.1 with seat and back covers

##### Folding:

If your Jump is equipped with a seat and back cover please proceed as follows:

- Secure the wheelchair from rolling away,
- if necessary loosen the stabilizing tube,
- **(1+2)** Remove the Velcro between back and seat covers and guide it back,
- **(3)** remove seat and back cushion,
- lift up the footrest/s
- if necessary detach the leg support (Jump beta DLS frame)
- **(3)** grab the seat cover in the back and front and pull it up until the Jump is folded,
- **(4)** secure the folded Jump with the fold fixation band,
- **(5)** if necessary, remove the wheels for transport,
- if necessary, remove the casters at the quick release axle.
- Secure ALL parts in the car so that they do not fly around in case of sudden braking.

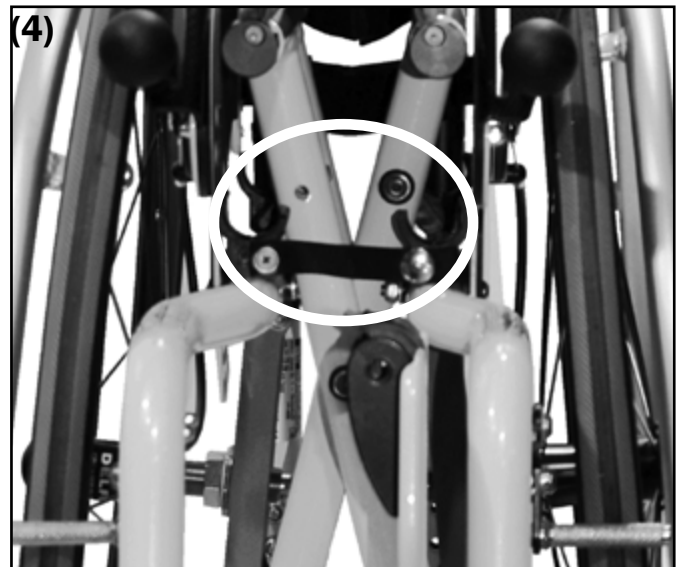

**Unfolding:**

- **(1)** If necessary, place the side guards (Jump beta BSA) in and make sure that they are tightly in place,
- If necessary, put the rear wheels and casters back on and be sure of a firm fit.
- Tip the wheelchair sideways toward you (the opposite rear wheel is not touching the ground),
- Loosen the fold fixation band (see 3.4.1 picture 4),
- push the crossbar apart until they have snapped into the bearing blocks,
- place the wheelchair on both wheels and secure it from rolling away,
- if necessary, close the stabilizing rod tightly,
- place the Velcro connection back/seat on the seat,
- put on the seat and back cushion,
- **(2)** if necessary, replace the leg supports (Jump beta DLS), make sure that the locking pins **(A)** have locked tightly in to place (the leg support cannot be removed, also see 3.12.3),
- get in and close the footrest/s (if necessary lock them).

**3.6.2 with SeatFix and/or curved back plate**

With the equipment with SitzFix and/or firm curved back plate, to fold/unfold precede analog:

- Secure the wheelchair from rolling away,
- **(3)** if necessary, loosen the stabilizing rod,
- **(4)** unlock the curved back plate and remove it,
- **(5)** if necessary, unlock the SitzFix and remove it,
- open footrest/s,
- grab the cross brace rods on both side at the front end and pull them up until the Jump is folded,
- fixate the folded Jump with the fold fixation band,
- If necessary, remove the casters at the quick release axle.
- Secure ALL parts in the car so that they do not fly around in case of sudden braking.

To unfold the Jump with SitzFix and/or curved back plate, precede analog.

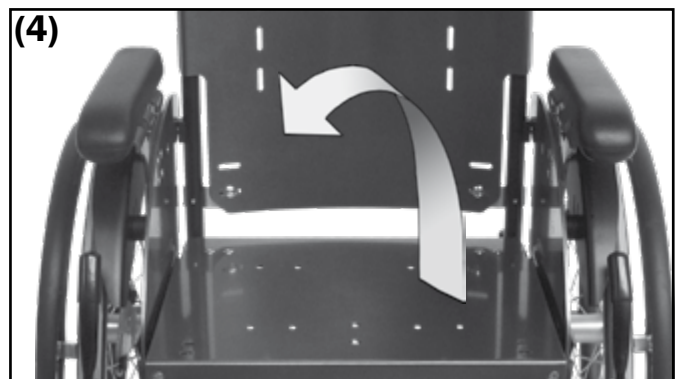
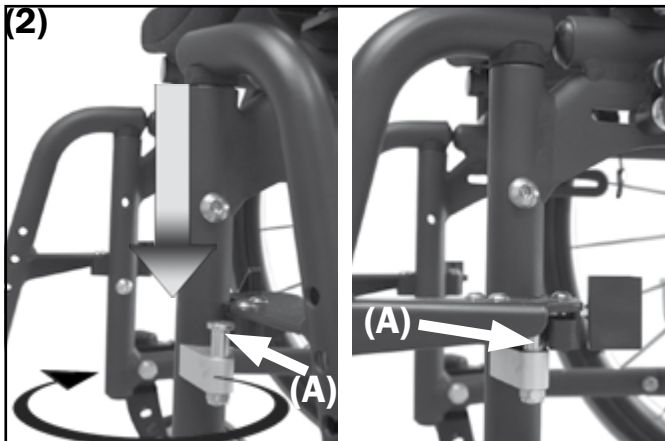
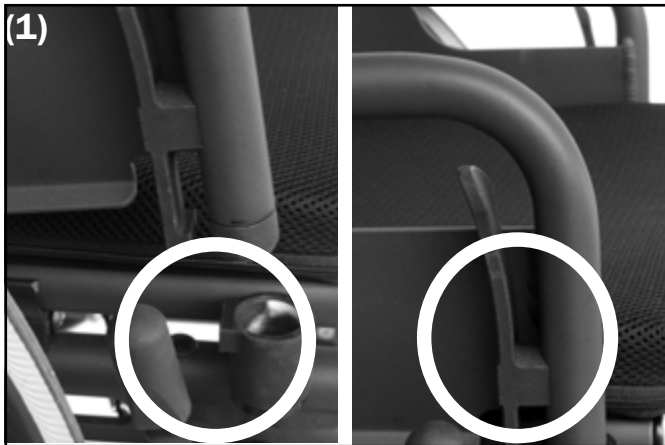



### 3.7 Seat and back cover

(1) For adjustable seat and/or back covers, the Velcro parts (A+B) must always overlap a min. of 8 cm.

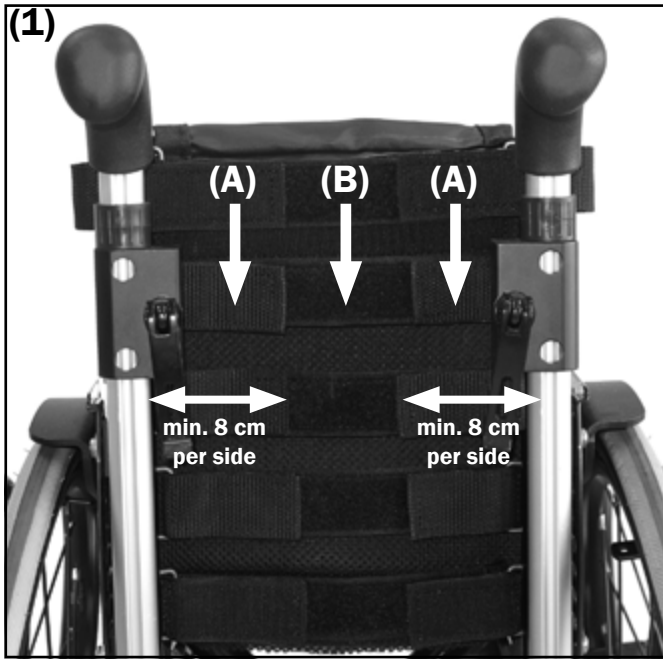

### 3.8 Firm seat plate (SeatFix) and curved back plate

(2) To **unlock** the firm seat plate (SeatFix):

- pull both levers (A) under the seat, inward
- and turn them 90°.
- The levers stay in this position.

To **lock**:

- first place the seat plate on the front edge of the seat tubes and
- push it by the back edge down until it snaps into place.
- After, lock the SeatFix as described above.

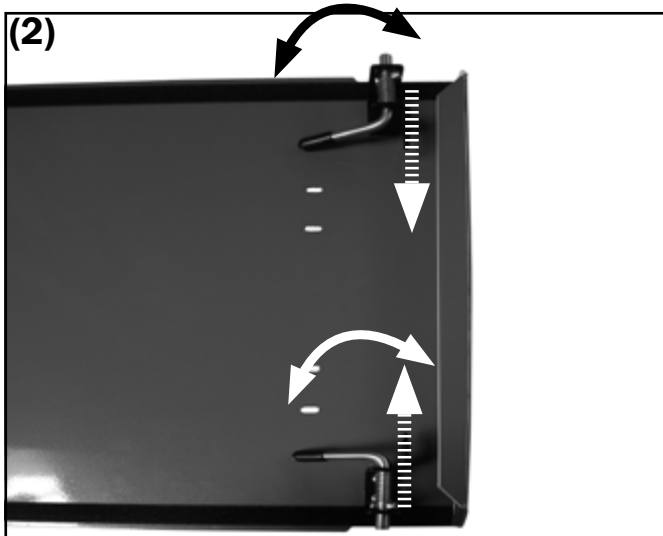

(3) To **unlock** the firm curved back plate:

- pull both locking levers (A) out
- and turn them 90°.
- The levers stay in this position.
- Pull the bolts (B) up out of the slots (C).

(4) To **lock**:

- First place the curved back plate with the bottom bolt (A) on the slot (B),
- then guide it down until the upper bolts (C) are also in the slot.
- After, lock the curved back plate as described above.

#### **⚠ ATTENTION**

The wheelchair is only safe and usable with firmly locked seat and/or back.

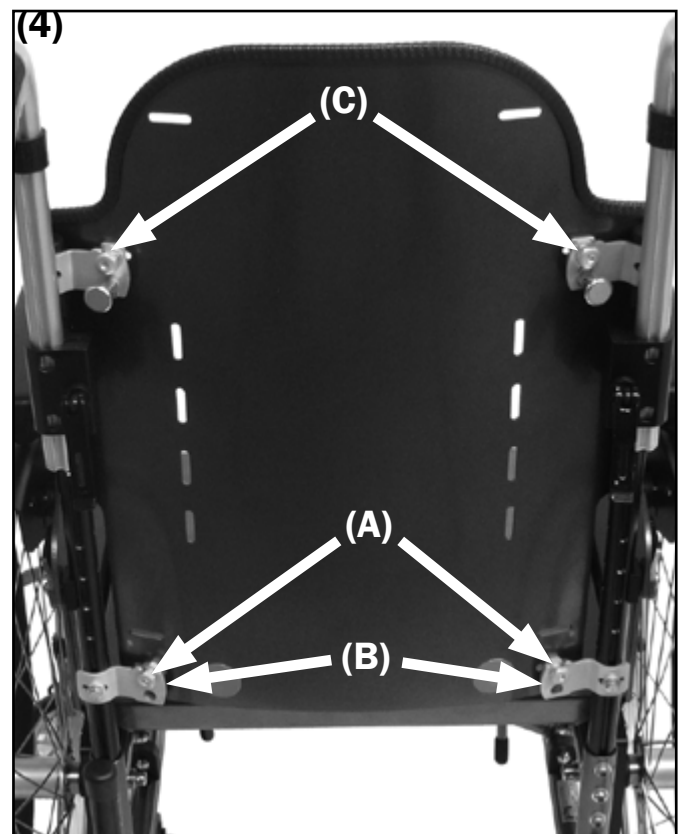
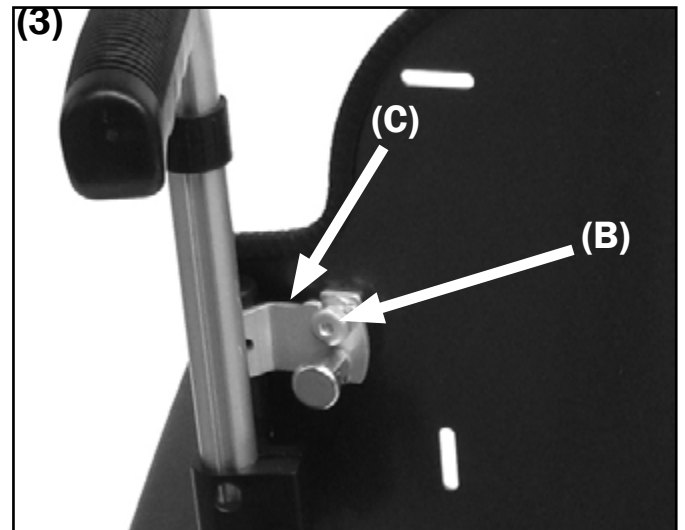



### 3.9 Push handles

**⚠ ATTENTION**

All push aids (push handles/push bails) are only there **TO PUSH** the person in the wheelchair.

For all various push aids please regard:

**⚠ ATTENTION**

**NEVER** carry the wheelchair with passenger over an obstacle (stairs, steps, curb sides etc.).

**⚠ ATTENTION**

The eccentric clamps of the pull-out push handles can loosen under adverse conditions. Before overcoming each obstacle, be sure to check them to make sure they are tightly closed.

**⚠ ATTENTION**

The tripod spring must always be visibly sticking out of the holes at the bottom of the holder.

**⚠ ATTENTION**

Do not hang any objects (bags etc.) on the push aids!  
**DANGER OF TIPPING OVER**

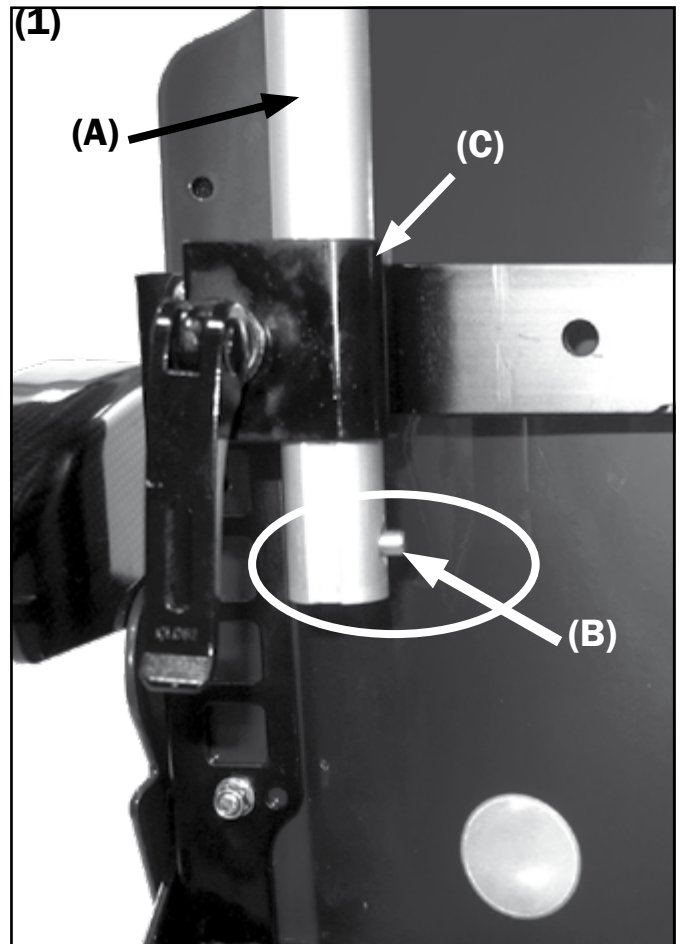

#### 3.9.1 Pull-out push handles

##### Removing/applying the push handles

(1) At the bottom end of the push handles (A) there is on each side one safety button (tripod spring) (B), which prevents the push handle from sliding out of the holder (C) while adjusting the height.

**(2) To remove:**

- open the eccentric clamp (A).
- Push the safety button (B) on the push handle,
- hold it in this position and simultaneously pull the push handle out of the holder (C).

**To apply:**

- open the eccentric clamp,
- push the safety button in the holder,
- guide the push handle in the holder
- and close the eccentric clamp.

**⚠ ATTENTION**

Be sure that the push handles are absolutely tight and the tripod spring is visible at the end of the tube. If necessary, reset the clamp force of the setting screw (D).

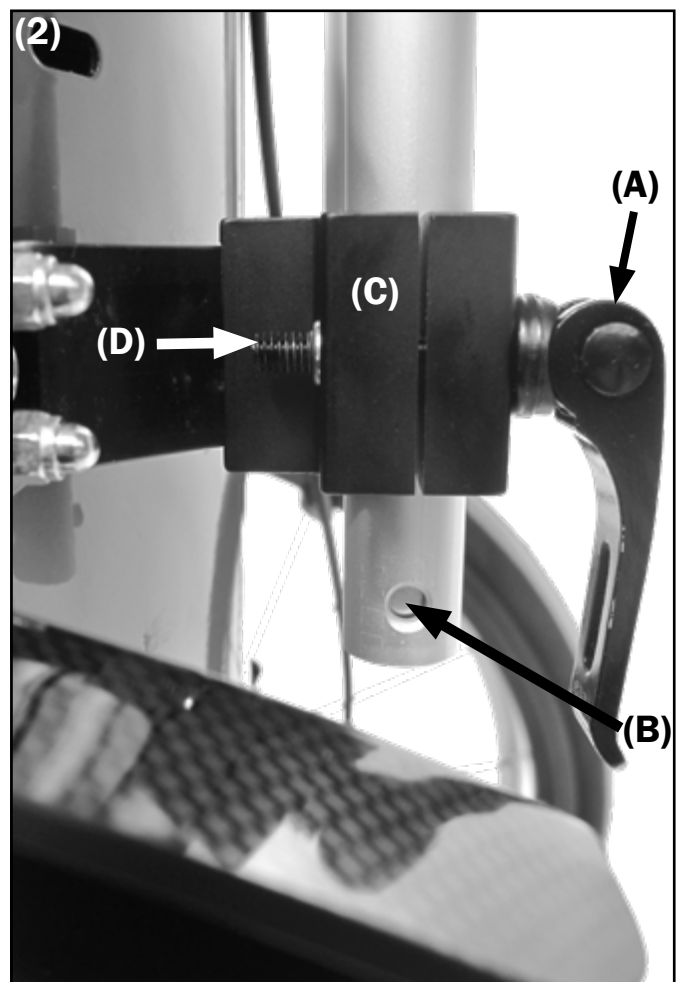

### 3.9.2 Push handles with push bar

On all of our wheelchairs a push bar can be attached to the long handles.

The wheelchair stays foldable. Additionally, the push bar stabilizes the back and creates a similar use as a stabilizing bar.

**(1)** To remove the push bar loosen the star knob screw **(A)** and swing it down.

To close, guide the push bar under the open star knob screw until it stops and tighten the screw.

#### **⚠ ATTENTION**

**Please regard the warning instructions stated in 3.9!**

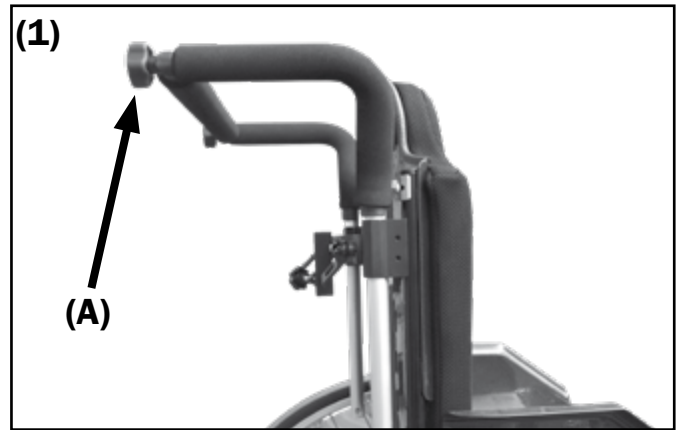

### 3.10. Side guards

#### 3.10.1 Standard side guards

All side guards, except the ones that can swing off (desk or long side guard), are adjusted to your needs and tightly attached by your rehab technician.

#### **⚠ ATTENTION**

**Between side guard/wheel cover and rear wheels is an INJURY RISK. Do not grab between the side guard and the rear wheels.**

#### 3.10.2 Desk side guards/side guards long

The desk and the long side guards can be folded away swung inward and completely removed.

**(1)** In order to open or swing backward and remove these side guards press the lever **(A)** and put it into the desired position **(2-4)**.

After locking, make sure that the lever **(A)** from the side guards has snapped back into the lock **(B)**.

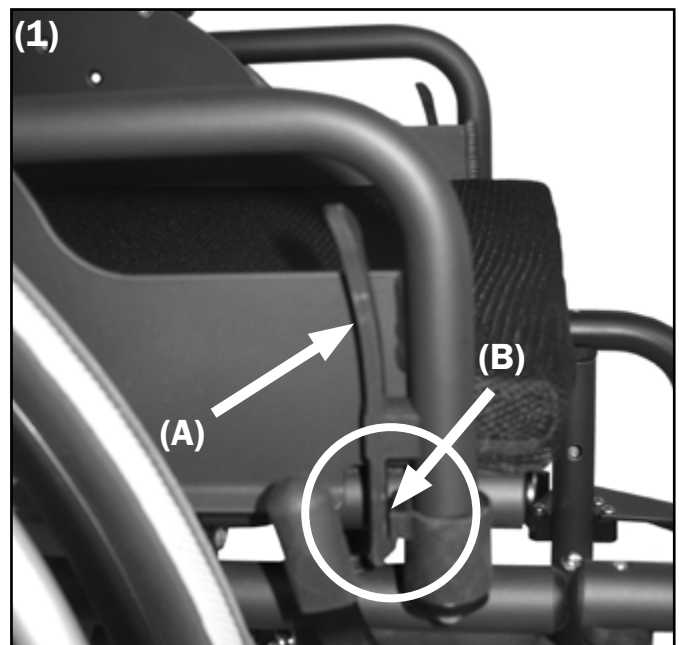

### 3.11 Armrests

All height **fixated** armrests are tightly screwed on by your rehab technician.

**(5)** The height **adjustable** armrests can be operated as follows: unlock the armrest with the locking lever **(A)** on the bottom of the arm cushion and pull the cushion in the desired position. Let go of the lever and let the armrest snap into place.

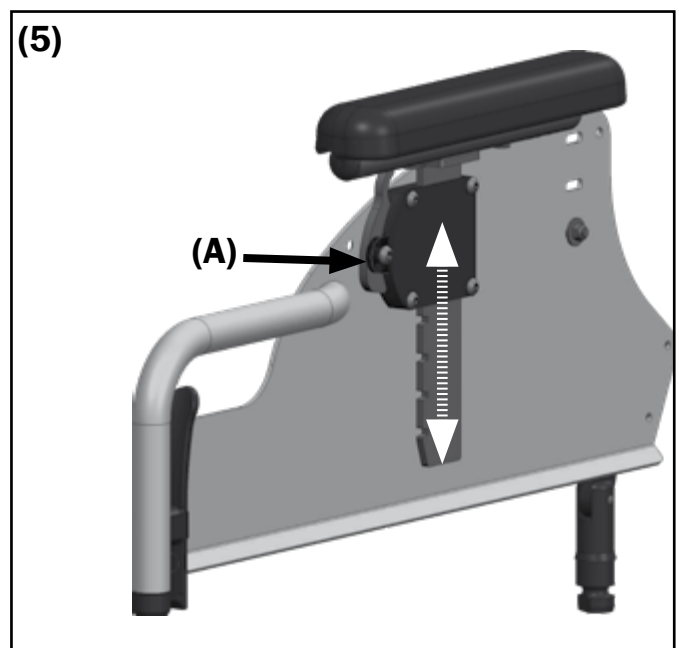

### 3.12 Leg supports

#### ▶ INDICATION

The leg supports are ideally fixated (A) when the whole thigh is evenly resting on the seat cushion to about 2 finger widths in front of the back of the knee, while the leg is resting on the footrest at a right angle.

A too high adjusted footrest can result in a bent pose in the pelvic area and a too low adjusted footrest can result in jams in the back of the knees and can cause spasms.

#### ⚠ ATTENTION

THE FOLLOWING HAZORD INDICATIONS ARE TO BE REGARDED WITH ALL TYPES OF LEG SUPPORTS!

#### ⚠ ATTENTION

NEVER LIFT OR CARRY THE WHEELCHAIR WITH A PASSANGER BY THE LEG SUPPORTS AND/OR FOOTREST/S.

#### ⚠ ATTENTION

THE DIVIDED FOOTRESTS ARE NOT SUITABLE FOR USERS WITH TONE DYSREGULATION (SPASMS).

#### 3.12.1 Footrests can be folded to the side or to the back

The footrests stay in a horizontal position, after opening, through the snap-action mechanism. For getting in and out of the wheelchair, fold the footrest/s up to the side or backward after you have (if necessary) unlocked them.

#### 3.12.2 Leg support with continuous footrest: can be elevated and swings to the side

The footrest can be elevated to the side and additionally it can swing to the side in order to obtain the greatest possible legroom. After elevation it stays in a horizontal position through the snap-action mechanism.

#### ⚠ ATTENTION INJURY RISK

Before you swing the footrest to the side fold it up so you do not hurt anyone surrounding you.

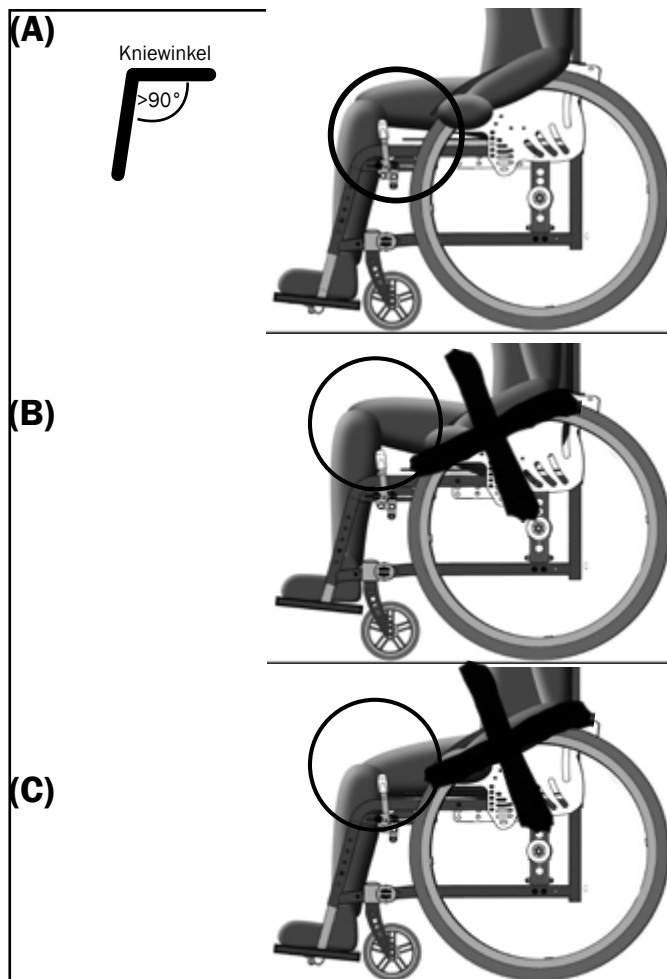

### 3.12.3 Leg support detachable and swings to the side

The leg support of the Jump beta can be swung to the side and completely detached in order to, e.g. accomplish activities of daily living.

#### **i** INFORMATION

**You should let your rehab technician set the height and the angle as well as take care of the precision work of each footrest.**

#### Detaching the leg support

**(1+2)** Unlock the leg support by pushing the lever in **(A)**. After, turn the leg support 90° out. The leg support can only be pulled out of the holding pipe **(B)** in this position.

#### Attaching the leg support

**(3)** The leg support can only be attached in an outward turned position. For this, guide the plug bolt **(A)** in the guide tube **(B)**. The locking mechanism **(C)** is guided on to the locking bolt **(D)** and locks in place when you turn the leg support forward.

#### **⚠** ATTENTION

**The leg support is only operable when the locking mechanism (C) locks in place in the locking bolt (D). It then cannot swing to the side nor be detached.**

### 3.12.4 Leg support can be elevated

The leg support which can be elevated can – as described in the previous part – also swing to the side and be detached. Both systems can be combined.

#### Detaching the leg support

**(4)** Pull the leg support completely out of the guide tube, turn it out and detach it (as described in the previous part).

#### Attaching the leg support

**(5+6)** With the leg support in an outward turned position (90°), place it with the plug bolt **(A)** half way in the guide tube **(B)**, turn it forward and then place it all the way in to the guide tube. The locking slot **(C)** snaps in the bolt **(D)** and prevents that the leg support turns to the side.

#### Setting the height

**(4)** Loosen the clamp lever **(A)**, place the leg support in the wanted position, retighten the clamp lever **(A)**.

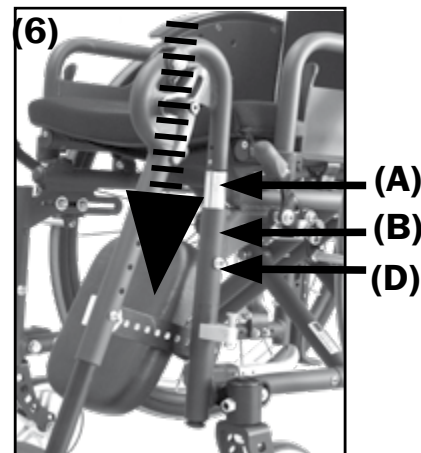
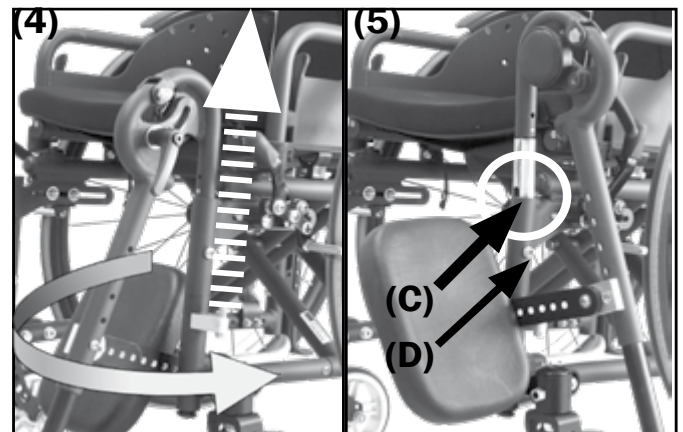
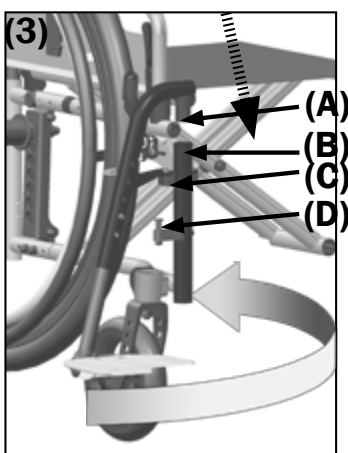
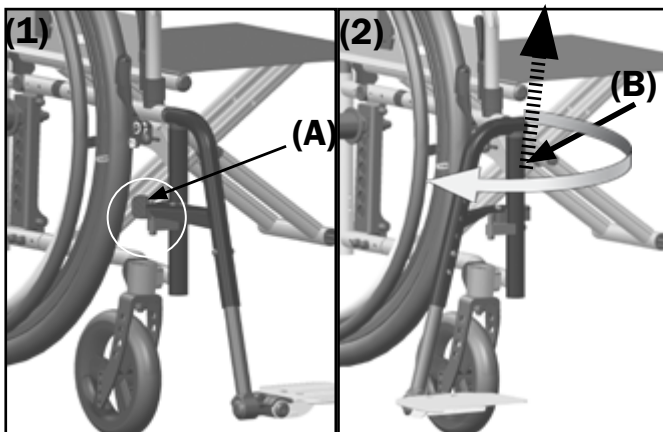



### Setting the leg rest

Remove the screws **(B)** and/or **(C)** and place the leg rest in the wanted position. Retighten the screws **(B+C)**.

### Precise adjustment of distance and angle

Loosen the adjusting screws **(C+D)** and set the wanted position. Retighten the screws **(C+D)**.

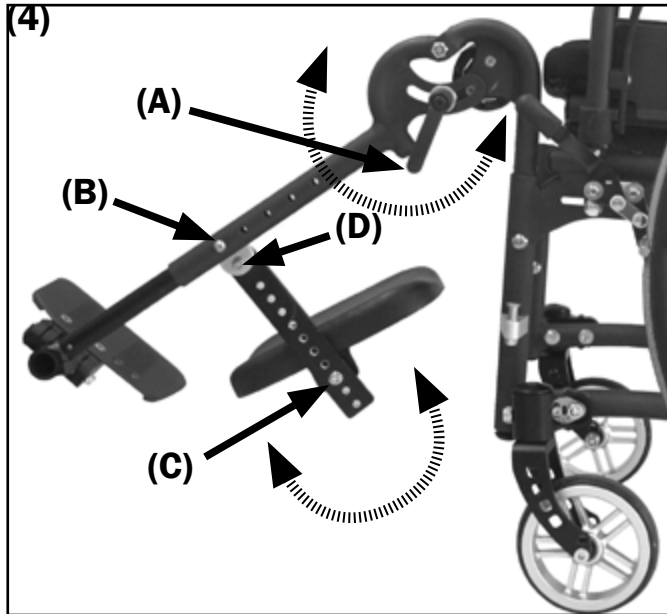

### 3.12.5 Locking mechanism for continuous footrest

In order to prevent the continuous footrest from opening unintentionally and you injuring yourself we highly recommend a locking mechanism.

**(5+6)** To open/unlock pull the latch **(A)** forward and lift the footrest at the same time.

- To close/lock pull the latch **(A)**.
- Close the footrest with the claw **(B)** in the joint bolt **(C)**.
- Release the latch so that you can hear it snap into place.

### ⚠ ATTENTION

**Make sure that you do not bruise yourself on the locking mechanism while handling and/or that you do not lean too far forward: DANGER OF FLIPPING OVER**

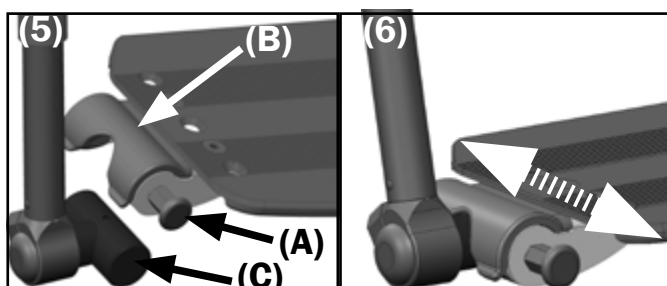

### 3.13. Brakes

**(3)** Every wheelchair is equipped with two wheel locks (so called knee lever brakes).

They consist of:

- brake pressing bolt **(A)**,
- brake lever **(B)** and
- adjustment screw **(C)**.

### ⚠ ATTENTION

**THE KNEE LEVER BRAKES ARE ONLY TO BE USED FOR PLACING THE WHEELS IN A RESTING POSITION. THEY ARE NOT TO BE USED TO BRAKE WHILE DRIVING.**

#### 3.13.1 Braking while driving

To brake, only use the hand rims or, if available, the drum brake. Please note that aluminum hand rims heat fast due to friction.

### ⚠ ATTENTION

**While braking, forces occur that you must be able to handle. Therefore, a few indications here:**

**You generally slow your wheelchair down (when physically possible) by applying simultaneous pressure with both hands to both hand rims.**

**Unevenly applied pressure causes unwanted swerving.**

**While driving downhill a higher strain for braking occurs. Do not shy away from getting help.**

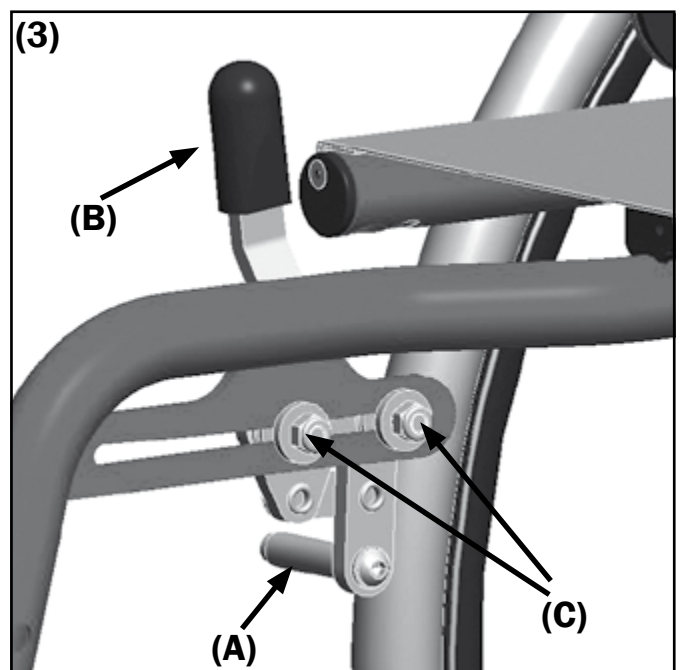

### 3.13.2 Knee lever brake (wheel lock)

#### ATTENTION

Be sure to check the functionality of the brakes before each use. Possible damages or function defects can occur from:

- too low tire pressure,
- wetness, snow, mud etc.,
- worn off profile,
- worn off brake bolts,
- loose screws on the brake bolt,
- dirty drum brakes,
- defected Bowden cables,
- too great of a distance between brake bolts and tire.

### 3.13.3 Drum brake as driving brake

The drum brakes can be used as a service brakes or driving brake (see above: 'possible damages').

(1) In order to brake, pull the control lever up (A) and apply the same pressure to both brake levers otherwise you will swerve unwillingly. Only use the blocking lever (B) to secure the control levers in a locked position.

### 3.13.4 Drum brake as wheel lock

The drum brakes can also be used as wheel locks (see above: 'possible damages')

(2) To fasten the drum brake, pull the lever up (A) and lock the blocking levers (B) in the notches (C).

To unlock, pull both levers a little further up until the blocking levers automatically unlock.

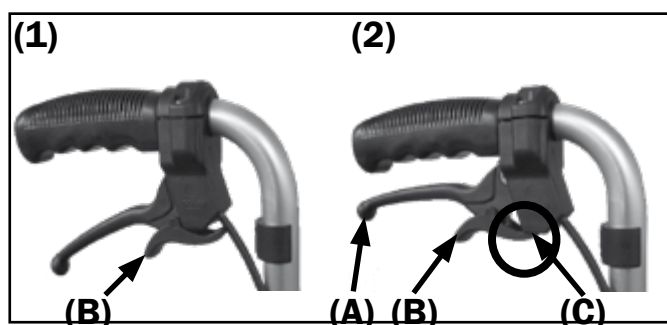

### 3.13.5 Locking the wheel lock

(3) The wheel locks can be locked in the open or closed position. This is impartial if the wheelchair is additionally equipped with drum brakes.

#### Unlocking

Pull the locking bolts on both sides (A) out of the holders (B) and turn those 90° so that they do not stick in the slots (C) anymore. Place the brakes in the wanted function.

#### Locking

Turn the bolts (A) back 90° so that they slide back into the slots (C) and snap into place.

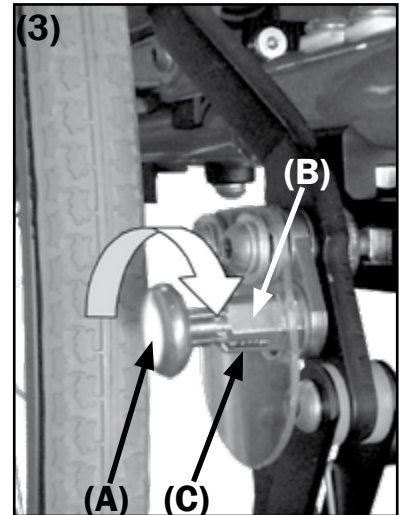

### 3.13.6 Rollback blocking

(4) The rollback blocking hinders the wheelchair from rolling backwards at a max. load capacity of 90 kg on slopes of max. 12,3% (=7°) without hindering the forward drive.

#### To activate

On both sides, clasp with the red levers (A) the locking pin (B) to the rear wheel.

#### To deactivate

Flip back both locking pins (B).

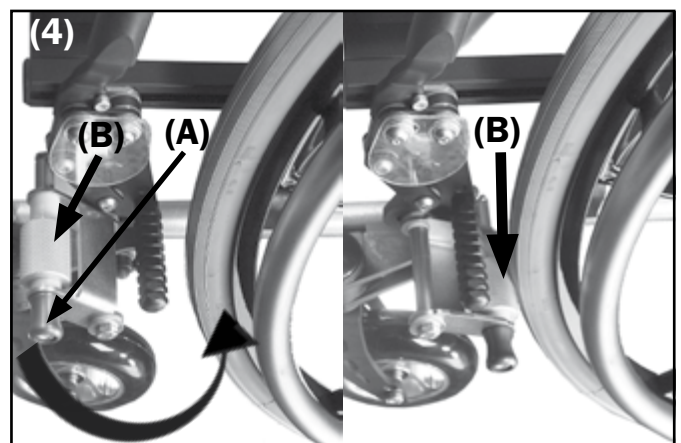

### 3.14 Anti-tipper

(1) To activate push the anti-tipper (A) down using the tread element (B), turn it 180° and let go so the positioning slot snaps into the arresting bolt (C) inside the pipe.

To deactivate push the anti-tipper on the pipe (A) slightly further down, turn it 180° and let go so it snaps into the positioning slot.

**⚠ ATTENTION**

Please read the respective chapters of the SAFETY INSTRUCTIONS.

**⚠ ATTENTION**

Make sure that the extension is always firmly snapped into its final position because a loose anti-tipper cannot fulfil its function properly and may cause injuries of the assistant's ankle area.

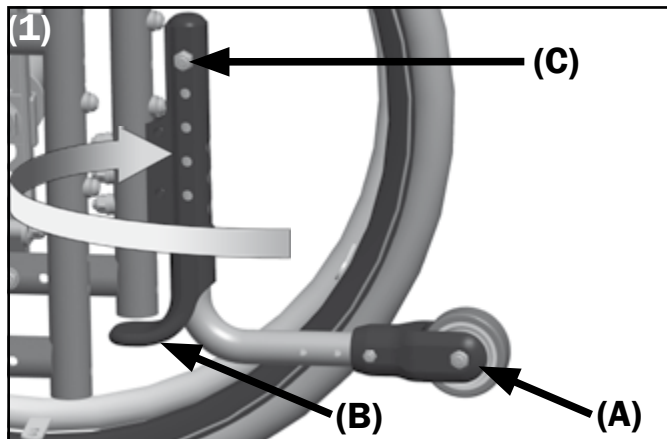

### 3.15 Back

There are three different kinds of backs:

- (2) standard
- (3) settable back angle
- (4) adjustable back angle

You do not have to change anything with the standard back as well as with the settable back.

**⚠ ATTENTION DANGER OF TIPPING OVER**

With the back angle you influence the centre of gravity of the wheelchair and with it its tilting behavior.

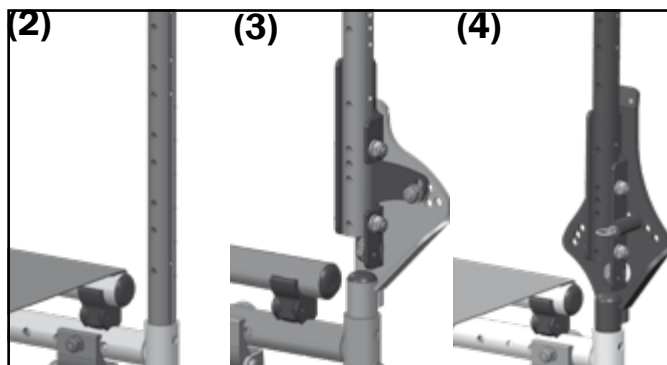

#### 3.15.1 Setting the back angle

The back angle is set by us ex works according to the terms from your therapist/rehab technician.

**⚠ ATTENTION**

It is important that you let your qualified rehab technician carry out any changes.

#### 3.15.2 Adjusting the back angle

To adjust the back angle:

(5+6) loosen the locking bolts (A) on both sides with the cable control and adjust the back in small raster steps (B) from 80° to 120° to the wanted angle.

To fold down the back:

with the ring (C) pull on the cord and loosen the locking bolts on both sides and fold the back forward. The raster bolts must go in to the last hole.

Be sure that both bolts (A) are secure in the raster holes (B). They must visually stick out of the angle element (D).

To undo the angle adjustments proceed in the same manner.

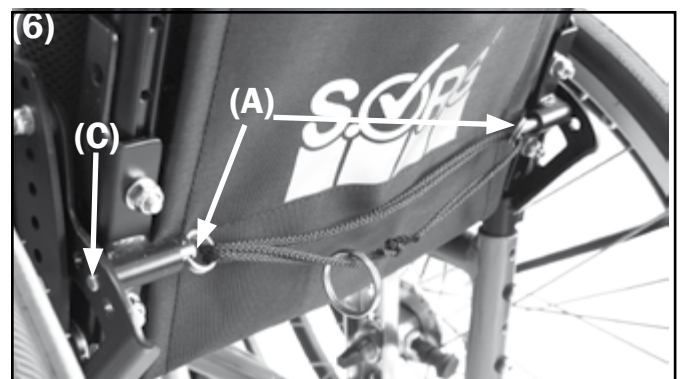
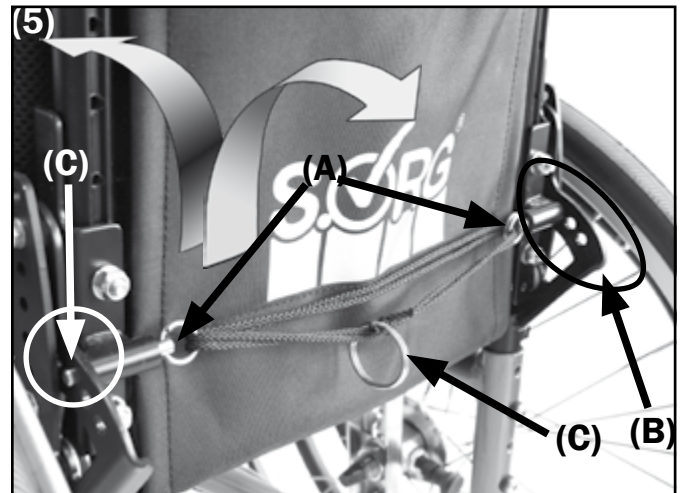

### 3.15.3 Back extension submersible

**(1-3)** To extend and submerge the back extension proceed as follows:

- remove the head cushion **(A)**,
- loosen the star knob screws **(B)** on both sides,
- pull the back extension equally up,
- (Attention: do not tilt!)
- turn both star knob screws **(B)** tightly and
- fasten the head cushion **(A)** on the front of the back extension with the available Velcro bands.

#### ATTENTION

**THE SUBMERSIBLE BACK EXTENSION IS NOT SUITABLE AS A HEAD REST FOR TRANSPORTING IN A VEHICLE!**

### 3.16 Head rests

There are two versions of the head rest - with a square-type tube **(2)** or a special section tube **(3)**. Both kinds can be adjusted to the user in the same way:

#### **(2+3) Height adjustment:**

- open the eccentric clamps **(A)**/star screw **(A)**,
- adjust the desired height,
- tighten screws/clamps **(A)** firmly.

#### **Adjustment of distance:**

- open clamp lever **(B)**,
- adjust the desired distance,
- tighten clamp lever firmly.

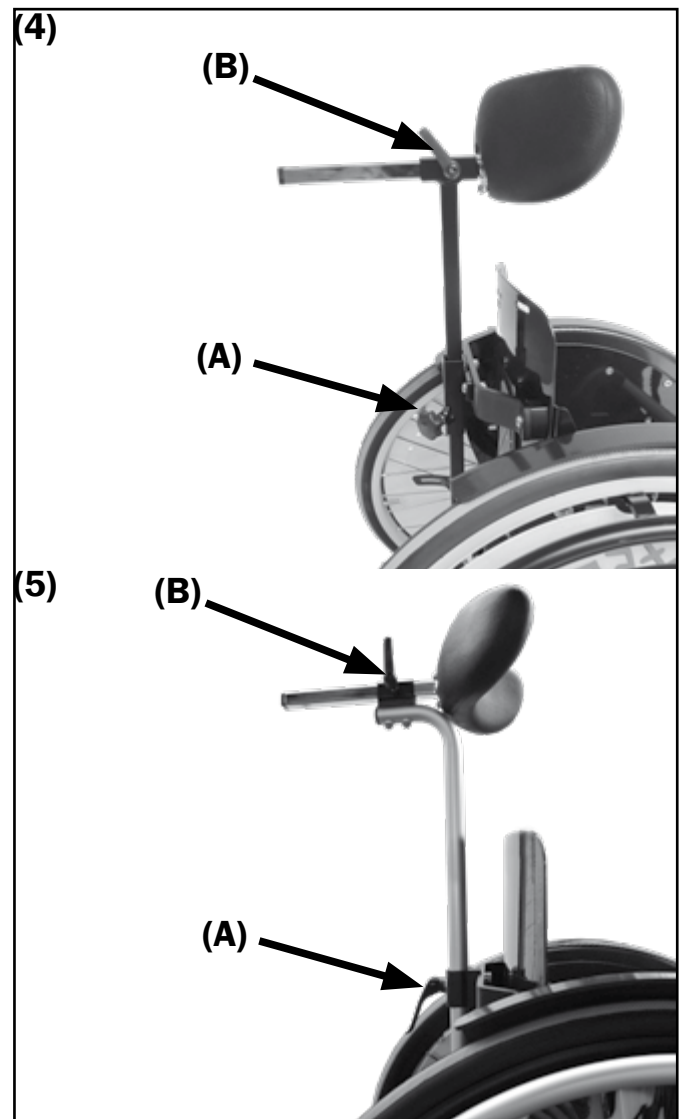
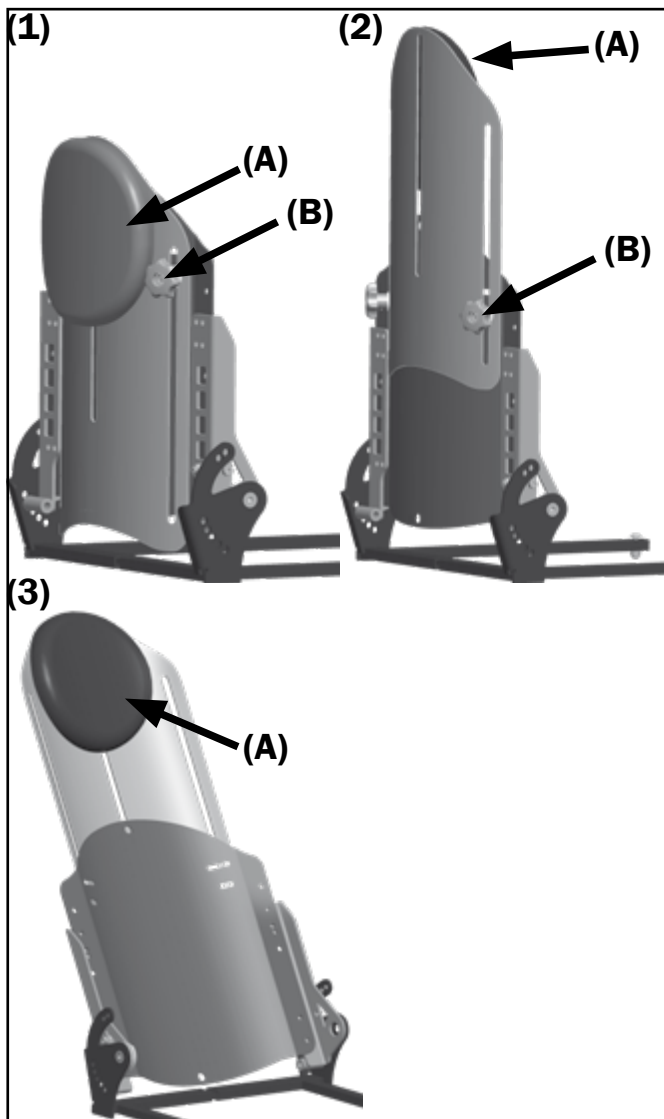



### 3.17 Therapy table

The therapy table is placed in the holder under the arm rests.

(1) Guide both tubes (A) of the therapy table simultaneously without tilting it (!) in the holders (B) fixate it then in the desired distance with the star knob screw (C).

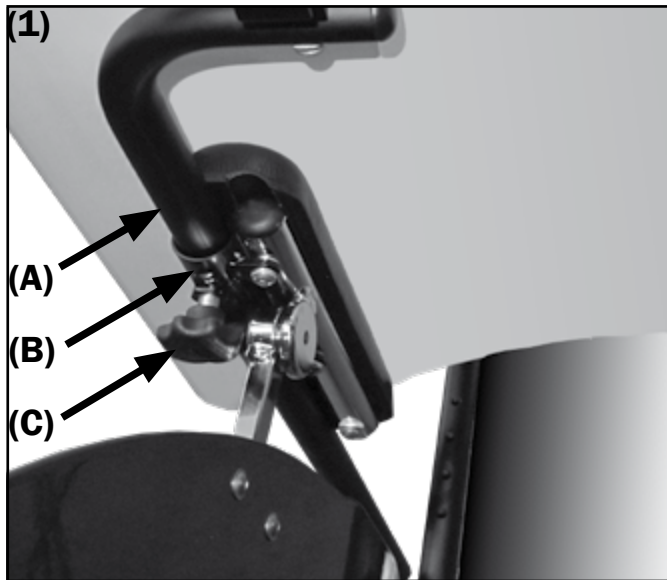

### 3.18 Abduction wedge

The abduction wedge is mounted under the SeatFix. The height can be adjusted in 1,5cm intervals, the distance is infinitely variable.

#### Adjusting the height:

- Remove star knob screws (A) completely,
- shift the wedge with holder along the row of holes (B) into the desired height,
- replace star knob screws (A).

#### Adjusting the distance:

- loosen star knob screws slightly (A),
- slide the wedge via the star knob back and forth into the desired position,
- tighten star knob screws (A).

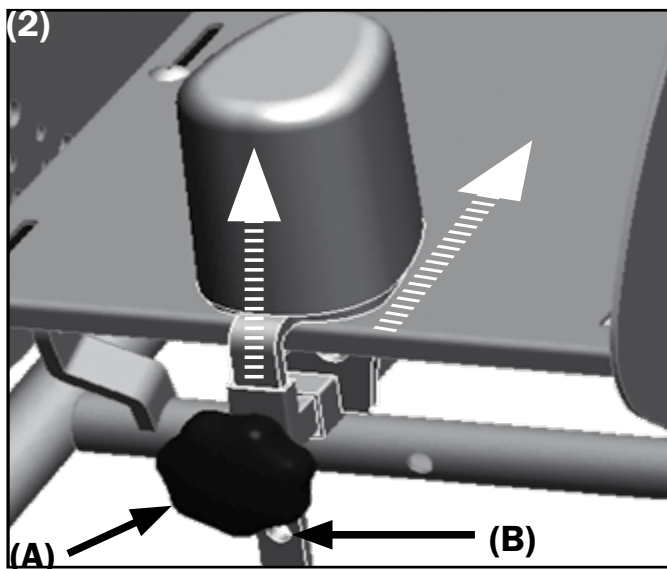

### 3.19 Thorax truss pads

(1) Both kinds of thorax truss pads can open and close. To do so, push the red button (A) and simultaneously push the truss pad frame back or forward. They snap into position when you release the button (A).

(2) In order to fixate the individual frame members (B) or extension pieces in a certain position, tighten the screw (C) on the joints with a suitable Allen wrench.

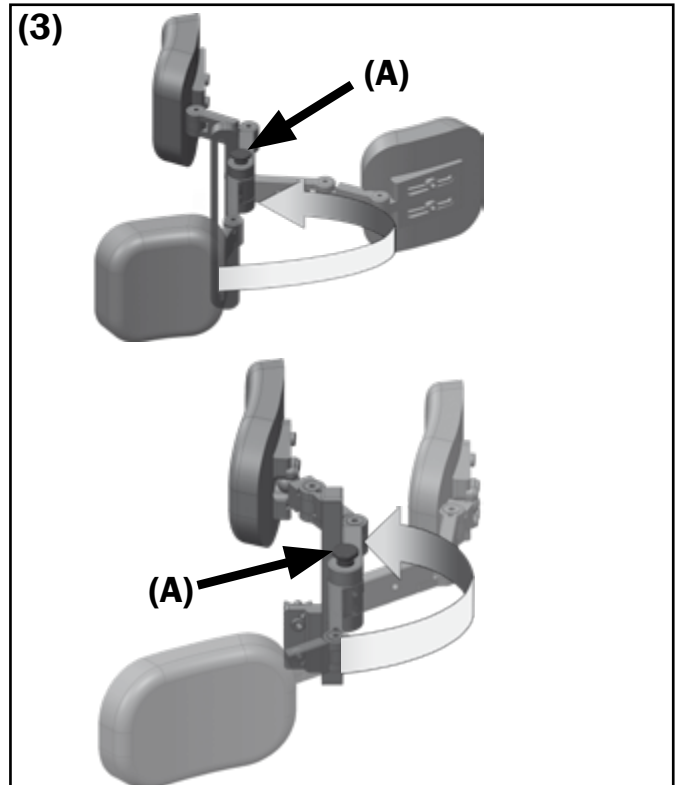

(2) The position of the cushions can be adjusted or fixated through the screws (D).

### 3.20 Tipping lever

**⚠ ATTENTION DANGER OF FLIPPING OVER**  
This maneuver should only be done by experienced and strong accompanying people.

In order to pull a wheelchair driver in his/her wheelchair over a ledge proceed as follows:

- if necessary, deactivate the ant-tipper,
- grab the wheelchair tightly on both push handle or push bail,
- push on the tipping lever with one foot as you
- **CAREFULLY AND AT THE SAME TIME** tip the wheelchair towards you and in this pose pull it over the obstacle.

### 3.21 Cane holder

**⚠ ATTENTION**  
Fixate your cane with the appropriate Velcro band on the back of the wheelchair so that it doesn't accidentally get between the spokes.

### 3.22 Outdoor Front End (push aid for outside)

#### **⚠ ATTENTION**

The push aid can only be attached if there is no user sitting in the wheelchair.

#### **⚠ ATTENTION**

The push aid is designed for a max. speed of 8 km/h. A higher speed is not allowed.

#### **⚠ ATTENTION**

Going downhill and driving with a tilted seat, it is important to be extra careful.

#### **(1-4) Mounting the pushing aid**

- Close the wheelchair's wheel locks.
- Tip the wheelchair slightly back and/or place the casters on the jack up aid **(A)**.
- Lock the latches **(B)** left and right in an opened position (pull out and turn 90°),
- insert both bars **(C)** on both sides all the way into the adaption **(D)**.
- Close the latches again, (the latches **(B)** need to snap into place on the left and right),
- Remove jack up aid.

#### **⚠ ATTENTION**

After mounting, be sure to check whether the construction is firm and secure in the fixture and that it is locked safely.

#### **Removing the push aid**

To remove, proceed in reverse order.

#### **(4) Widening the push aid**

- Remove the screw joints **(E)** on both sides,
- place in desired width,
- replace all screws that may have been removed and tighten the screw joints.

### 3.23 Baggage holder

#### **⚠ ATTENTION**

Fold the baggage holder back whenever possible to avoid hurting someone.

#### **⚠ ATTENTION**

Load the baggage holder after you are seated in the wheelchair.

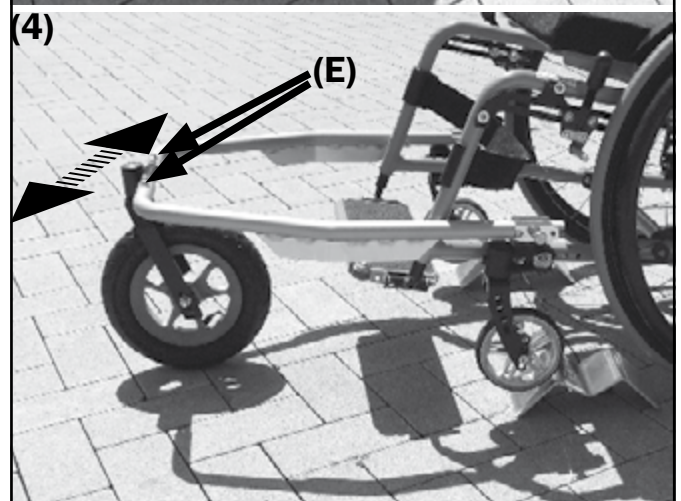
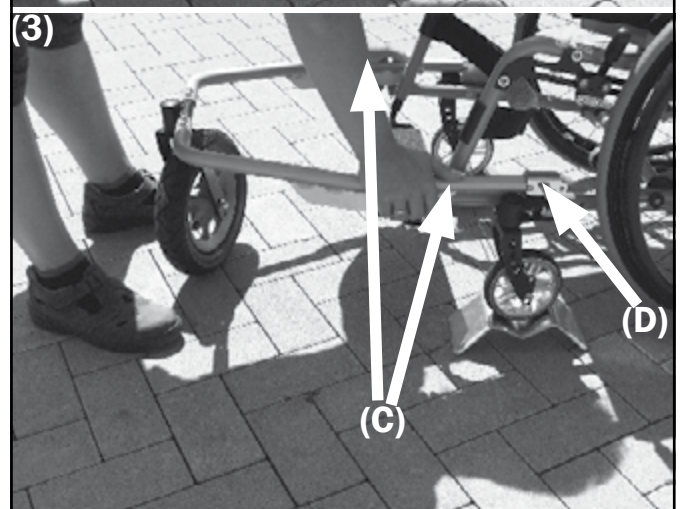
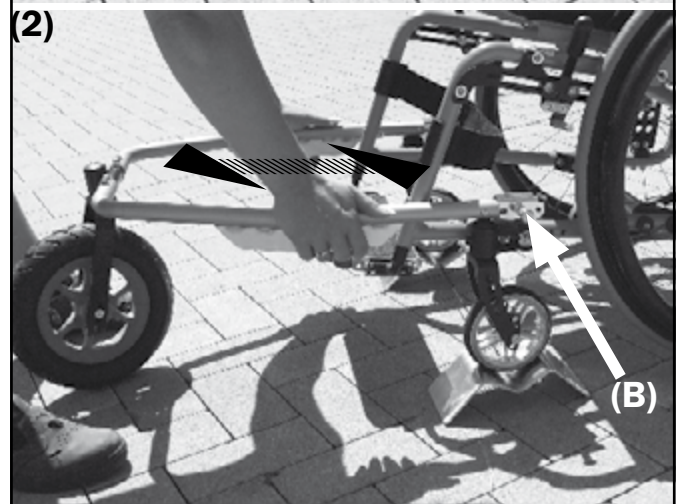
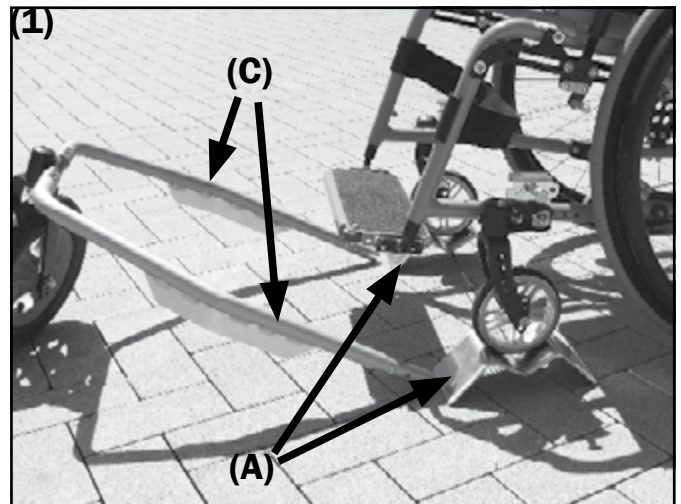

## 4. Repairs and Maintenance

### 4.1. Repairs

#### ATTENTION

**Do not conduct any reparations and/or maintenance work yourself. Contact your medical supply store. There, the staff is familiar with this work, has all necessary tools and are trained rehab technicians.**

If you have any questions or need help, our qualified rehab consultants are happy to assist you or turn to your specialized retailer, who is trained according to our regulations and who is capable of resuming consultations, service as well as reparations.

### 4.2 Spare parts

#### ATTENTION

Safety relevant parts or assemblies can only be built on or changed by a qualified sanitary house because of the safety hazard.

#### ATTENTION

**Only original spare parts can be used! They are available at your medical supply store.**

#### ►► INDICATION

Disruption can occur from assemblies from external companies which can lead to a safety hazard. Spare parts with the respective item number and drawings are available at your specialized store and can be downloaded under [www.sorgrollstuhltechnik.de](http://www.sorgrollstuhltechnik.de) or can be requested directly from us.

For a correct delivery of spare parts the appropriate series number of the wheelchair is to be stated! You will find these on the type label on the wheelchair's frame.

#### ►► INDICATION

**Every change or modification done on the wheelchair by your medical store is to be enclosed in this user manual with the corresponding information such as assembling indications and/or operation instructions and the date of the alteration is to be documented in the service record.**

### 4.3 Disposal

#### ►► INDICATION

**The wheelchair can only be disposed of after consultation and approval from your benefactor.**

As a general rule, the disposal of the wheelchair must conform to the respective national legal regulations. You may seek information about local disposal organizations from your city or municipal administration.

Our packaging materials are 100% recyclable. Metal parts may be put to scrap metal recycling or sent to our factory. Plastic and textile parts may be recycled as well.

### 4.4 Tire change

With a little bit of technical skill and suitable tools, you can fix a flat tire yourself. It is advisable to always carry a repair kit and an air pump for emergencies. Suitable air pumps can be purchased at your specialty store. An alternative would be a puncture repair spray which fills your tire with setting foam (available at the specialty store).

#### Dismounting

In case of a flat tire, remove the tire carefully from the rim with suitable mounting tools. Make sure not to damage the rim or the tube in the process.

#### Repair

Repair the tube according to the indications given on the reparation set, or replace it with a new one. Examine the rim and the interior of the tire for foreign objects which may have caused the flat tire. Only use rim bands which are in perfect condition to protect the tube from damage caused by spoke ends.

#### Mounting

Push the rim band over the valve and place the valve into the rim. Unscrew the valve screw nut. Now you can draw up the rim band effortlessly. Make sure that all spoke ends are covered.

Now push the lower tire part over the bead of the rim. Inflate the tire until round. Insert the weakly inflated tube into the tire cover. Check the tube for smooth fit. Then you can easily mount the upper part of the tire behind the bead of the rim with both hands. Start with the part of the valve which is faced away.

#### Inflation

Check if the tube is perfectly clamped between tire and cover.  
Check the valve fitting.



First inflate the tire with just enough air so you can still push in with your thumb. Check the fit of the tire on the rim. If the tire cover is not centered on the rim, deflate the tire a bit and readjust it.

Then inflate the tire to its maximum operating pressure (see tire cover) and close the valve with the protection cap.

## 4.5 Maintenance

### 4.5.1 Cleaning and care

#### ►► INDICATION

**Never treat the wheelchair with a high pressure cleaner! Please use silicon free, water based cleaning and care supplies.**

The indications on application given by the manufacturer are to be followed. Do not use any aggressive cleaning supplies such as dissolvers or hard brushes etc.

#### COATING

To tend the finish, we recommend using customary branded finish care products. Should the coating still be damaged through scrapes, hits etc. you may correct those spots with a touch up applicator available in the specialty store (apart from metallic and dormant colors).

#### PLASTIC PARTS

The clothing protection and similar parts consist of high quality plastic. Only clean these parts with warm water and neutral cleaning agents or soft soap.

#### PLEASE NOTE:

**When using customary plastic cleaners, the indications on application given by the manufacturer are to be followed.**

#### CUSHIONS AND COVERS

The covers of the molded firm seat and back parts may be removed with the zippers. We recommend washing them regularly with a mild detergent and low temperature in the washing machine.

#### PLEASE NOTE:

Please clean other cushions and covers (e.g. from seat shells) with warm water and hand soap. Many stains can be removed with a sponge or a soft brush.

In case of doubt, please consult the medical supply store, which built your seat shell, for advice on cleaning the cover.

#### FRAME

The frame and wheels must be cleaned regularly with a damp cloth and mild cleaning agent. Please dry well after.

#### CASTERS

Please remove rough dirt regularly from the casters, clean them with a damp cloth and mild cleaning agent and dry well. Please grease the wheel bearings and similar parts with customary grease.

#### PLEASE NOTE:

Please check the frame for corrosion damages as well as other damages on a regular basis. Oiling all versatile parts lightly and regularly obviates such damages and assures long use of your wheelchair.

### 4.5.2 Disinfection

To disinfect, water based agents should be used such as: Terralin, Quartamon, Med or Sagrotan.

The indications on application given by the manufacturer are to be minded and followed strictly.

#### INFORMATION

Before you disinfect the wheelchair be sure to clean all cushions and handles in the given manner.

#### INFORMATION

Do not use aggressive cleaning agents or solvents or hard brushes.

### 4.5.3 Reinstatement

#### ►► INDICATION

Before each reinstatement the wheelchair has to go through a complete, thorough and qualified inspection and disinfection.

#### ►► INDICATION

**The necessary measures for reinstatement are to be followed through according to a validated hygiene schedule.**



## 4.6 Service/Inspection

### 4.6.1 Check list

A yearly inspection from a qualified medical store is inevitable for the safe use of the wheelchair and for a long lifespan. Furthermore, the inspections serve as proof for the suitability for use in the case of a possible reinstatement.

For safety reasons and to prevent accidents resulting from abrasion not recognized on time, a yearly inspection is designated under normal operating conditions.

#### ►► INDICATION

**This is to be done according to the service list and to be documented in the service record.**

According to applicable law §33 subparagraph 1,4 BSG V (Service, Maintenance, Replacement Reserve) the inspection is part of the commitment of the benefactor and has to be acquired by him. For detailed coordination, we recommend you arrange agreements with your benefactor in the forefront of supplying medical aids.

The staff of the professional repair shop is familiar with the technique of the aid and can recognize building abrasion and if necessary they can conduct the needed reparations.

### 4.6.2 Check list yearly inspection

#### PREPARATORY WORK

If necessary, we recommend cleaning the wheelchair or individual parts of it prior to inspection.

#### VISUAL INSPECTION

Check frame, mounting parts and accessories for damage, defects in paint work and corrosion.

#### GENERAL INSPECTION

Check all fixing screws for firm fit and retighten them if necessary.

Check fixation of all mounted parts and readjust if necessary.

Check fixation of all plastic parts, handles, mounted parts spoke guard covers etc. and readjust if necessary.

Check brake lever device and extension for deflection and readjust if necessary.

Check all spring loaded devices (quick release axle, stand spring on push handle etc.) for proper functioning and replace if necessary.

#### CARRIAGE

Check fixation of caster and rear wheels.

Check functionality of the quick release axles.

Check tires, air pressure and valve, replace if needed.

Check caster bearing, caster fork and caster mounting bracket for condition, proper functioning and running characteristics.

Check the firm fitting of the anti-tipper and its functionality.

#### BRAKES

Make sure the brakes function properly

Make sure the Bowden cables function properly and replace if necessary.

Make sure the brake lever extension functions properly.

#### OILING AND GREASING

Clean and grease all pivot points of control levers and versatile parts as well as all bearings.

#### FINAL INSPECTION

General functional check-up of all mechanical adjusting devices.

Additional braking, steering and driving tests uphill and downhill.

### 4.6.3 Service List

The following service list is based on our long-term experience and is a mandatory guideline with which you can keep your wheelchair –possibly for a long time – in a safe to use condition. However, it does not give information about the extent of service or repair needed and observed on the wheelchair.

#### ATTENTION

**Please keep in mind, the even regular maintenance is not a guarantee for a safe use and road safety. If necessary, individual repairs and/or adjustment work is to be done immediately in order to ensure you are not in great danger.**





Considering possible reuse, the filled out service plan is an informative document about the mobilization of the wheelchair for the benefactor.

#### ATTENTION

**As a participant in public traffic, the wheelchair driver is responsible for maintaining the wheelchairs functional state and safe operating condition.**

#### ATTENTION

**Insufficient or neglected care and maintenance of the wheelchair pose a significant safety risk and automatically lead to limitations of product liability.**

WHEN?	WHAT?	COMMENTS
<p><b>Before each use</b></p>	<p><b>Check wheels/quick release axles for firm fit.</b> You must not be able to pull the wheel out of the quick release axle. The arrestor button must protrude the hub visually.</p> <p><b>Check air pressure</b> according to the manufacturer indication on the tire.</p> <p> <b>ATTENTION</b> <b>Regularly check the brakes for proper function!</b></p>	<p> <b>ATTENTION</b> <b>Too low air pressure and/or dirty tires as well as adverse weather circumstances can reduce the brake efficiency drastically and put you in danger. Fix all flaws yourself immediately or with an experienced carer.</b></p> <p>If the brake doesn't work correctly (worn out profile or braking bolt, loose brake lever etc.), contact a medical supply store immediately for qualified maintenance work.</p> <p> <b>ATTENTION</b> <b>The wheelchair (with full capacity) has to stand safely with pulled brake on a ramp with a 7° (=12%) decline</b></p>
<p><b>Preferably before each use</b></p>	<p><b>Check all screws for proper fit.</b></p> <p><b>Check frame and back tubes for damages.</b></p>	<p>Please check:</p> <ul style="list-style-type: none"> <li>• secure fit of the quick release axle, wheel adapter</li> <li>• angle adjustment elements (eccentric clamp or star knob screws) for proper functioning and completeness</li> <li>• fixation of foot rest</li> <li>• fixation of molded seat and back/seat shell</li> <li>• fixation of wheel guard</li> <li>• fixation of anti-tipper</li> <li>• proper functioning (clamping force) of all eccentric clamps</li> <li>• connection Velcro-fleece (seat and back belts) for proper functioning</li> </ul> <p> <b>ATTENTION</b> <b>If the welded seams are deformed and /or have fissures, contact a medical supply store immediately for qualified maintenance.</b></p>
<p><b>Every 4 Weeks</b></p>	<p><b>Retighten all screw joints</b></p> <p><b>Check tire profile</b></p> <p><b>Remove lint/dirt from casters</b></p>	<p>From daily use and the permanent vibrations screws can loosen. Therefore, we strongly recommend retightening <b>ALL</b> screw joints once a month.</p>
<p><b>Every 2-3 months (depending on driving performance)</b></p>	<p><b>Clean and grease all versatile parts</b></p> <p><b>Retighten spokes</b></p>	<p>All moving parts such as brakes, brake levers, quick release axles etc. Clean all parts thoroughly and remove old oil residue before greasing. After, Apply some drops of oil and wipe away excess oil.</p> <p><b>If possible have this done by your medical supply store!!!</b></p>
<p><b>every 6 months (depending on driving performance, earlier)</b></p>	<p><b>Check frame for cracks, corrosion and damages</b></p> <p><b>Maintain locking brake</b></p>	<p><b>Please have this done by the medical supply store!</b> Please remove seat and back unit as well as leg support and side guards/clothing guard for better exterior visual control.</p> <p><b>To be conducted by the medical supply store! Inspect brakes for symptoms of fatigues or abrasion.</b></p>

## 4.7 Technical Data

### 4.7.1 Measurements and dimensions

#### Dimension tolerance $\pm 5^\circ$

#### Abbreviations:

SW = seat width  
SD = seat depth  
BH = back height  
SH = seat height  
LLL = lower leg length

#### Data

Model: Jump beta  
German aid index N°: 18.50.03.0xxx or  
German aid index N°.: 18.50.03.1xxx  
German aid index N° requested  
Type: 485  
Type plate on frame pipe

#### Supporting points for transport:

- seat pipes when folded
- frame front-end left/right
- **NOT** the removable leg supports (remove them before carrying/transportation!)

### 4.7.2 Meaning of labels

The meaning of the individual labels is explained in the texts at the respective place.

The serial number consists of:

**XXX      XXXXXX    XX**  
Type Nr.    Order Nr.    Year

The type plate on the frame of Jump beta has the following meanings:

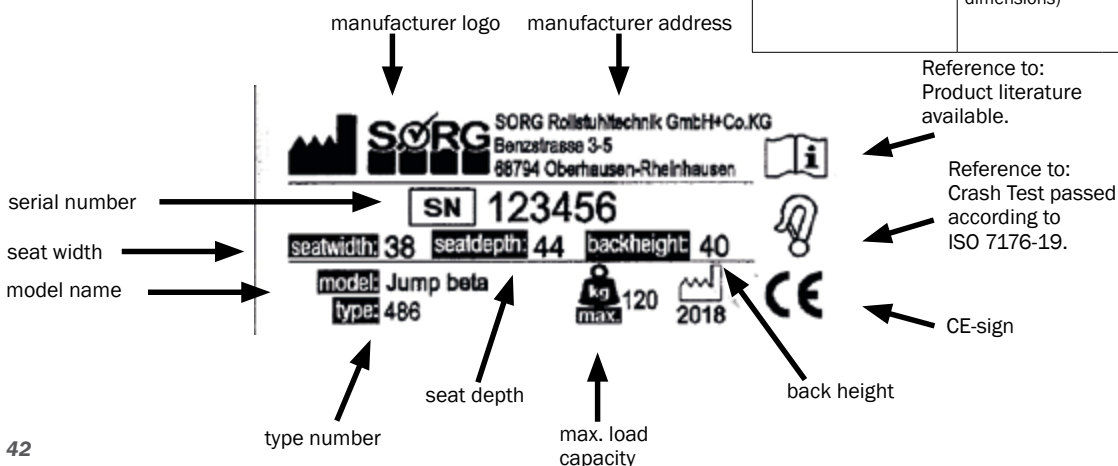

### 4.7.3 Technical data

#### Measurements Jump beta

Labelling		Measurements	Comments
<b>Seat width (SW)</b>	Sports frame PLS frame XL frame	28-50 cm 28-50 cm 38-50 cm	
<b>Seat depth (SD) in 2 cm steps</b>	Sports frame PLS frame XL frame	34-46 cm 38-46 cm 44-50 cm	Optional: growable (adjustable) max. 4 cm per SD
<b>Back height (BH) in 2.5 cm steps</b>		25-50 cm	
<b>From upper edge (UE) seat to upper edge foot rest</b>	Attachment interior	4,5 - 32,5 cm	The lower leg length (LLL) is the distance between UE of the seat and UE of the foot rest PLUS thickness of the seat cushion
	Attachment exterior	31,5-48 cm	
	XL attachment interior	8,5- 36 cm	
	XL attachment exterior	35,5-52 cm	
<b>Frame size 4</b>	Sports frame	57,4 cm	
<b>Frame size 5</b>	Sports frame	59,4 cm	
	PLS frame	61,5 cm	
<b>Frame size XL</b>	Sports frame	63,5 cm	
	PLS frame	66,1 cm	
<b>ETRTO wheel size 22"</b>		Ø 25-489	
<b>ETRTO wheel size 24"</b>		Ø 25-540	
<b>ETRTO wheel size 26"</b>		Ø 28-590	
<b>Camber inclination</b>		2°, 5°, 8°	
<b>Seat height (SH) front</b>	min.	415 mm	SH is the distance between UE of the seat and the ground WITHOUT seat cushion!
<b>Seat height (SH) front</b>	max.	575 mm	
<b>Seat height (SH) back</b>	min.	340 mm	
<b>Seat height (SH) back</b>	max.	580 mm	
<b>Total wheelchair width</b>	min.	SB + 200 mm	Dependent on the camber inclination, tyres and hand rim attachment
	max.	SB + 405 mm	
<b>Total wheelchair length</b>	min.	620 mm	(WITHOUT outdoor front-end)
<b>Total wheelchair length</b>	max.	1080 mm	
<b>Total wheelchair height</b>	min.	620 mm	Dependent on push handles
<b>Total wheelchair height</b>	max.	1480 mm	With height-adjustable push handles in max. position
<b>Permitted inclination</b>		6% = 3,5°	
<b>Permitted descent</b>		6% = 3,5°	
<b>Safety from tipping</b>		6% = 3,5°	
<b>Turning radius</b>		ca. 100 cm	Dependent on wheelchair size
<b>max. load capacity</b>		120 kg	
<b>min. empty weight fit for use = SW 24, 20" wheels, 4" polyurethane</b>		9,25 kg	Frame, side parts, rear wheels, casters, leg support, back and seat covers
<b>Individual weights</b>	Rear wheels	1,2 - 2 kg	Depending on size and version
<b>Tyres</b>	customary pneumatic tyres, sizes 1" or 1 3/8" or breakdown-proof tyres (same dimensions)		Optional: „Schwalbe Marathon Plus“ (pneumatic tyres 1" with breakdown-proof padding)

**4.8 DOCUMENTATION YEARLY INSPECTION**

Work done according to check list	Additional work carried out	date, signature, stamp medical supply store,



company stamp



SORG Rollstuhltechnik  
GmbH + Co. KG  
Benzstraße 3-5  
D-68794 Oberhausen-Rheinhn.

Fon +49 7254 9279-0  
Fax +49 7254 9279-10

[info@sorgrollstuhltechnik.de](mailto:info@sorgrollstuhltechnik.de)  
[www.sorgrollstuhltechnik.de](http://www.sorgrollstuhltechnik.de)  
Technical changes and  
misprints reserved.